



# Dell PowerEdge R520 Owner's Manual

**Regulatory Model: E19S Series**  
**Regulatory Type: E19S001**



# Notes, Cautions, and Warnings

-  **NOTE:** A NOTE indicates important information that helps you make better use of your computer.
-  **CAUTION:** A CAUTION indicates either potential damage to hardware or loss of data and tells you how to avoid the problem.
-  **WARNING:** A WARNING indicates a potential for property damage, personal injury, or death.

© 2013 Dell Inc. All Rights Reserved.

Trademarks used in this text: Dell™, the Dell logo, Dell Boomi™, Dell Precision™, OptiPlex™, Latitude™, PowerEdge™, PowerVault™, PowerConnect™, OpenManage™, EqualLogic™, Compellent™, KACE™, FlexAddress™, Force10™, Venue™ and Vostro™ are trademarks of Dell Inc. Intel®, Pentium®, Xeon®, Core® and Celeron® are registered trademarks of Intel Corporation in the U.S. and other countries. AMD® is a registered trademark and AMD Opteron™, AMD Phenom™ and AMD Sempron™ are trademarks of Advanced Micro Devices, Inc. Microsoft®, Windows®, Windows Server®, Internet Explorer®, MS-DOS®, Windows Vista® and Active Directory® are either trademarks or registered trademarks of Microsoft Corporation in the United States and/or other countries. Red Hat® and Red Hat® Enterprise Linux® are registered trademarks of Red Hat, Inc. in the United States and/or other countries. Novell® and SUSE® are registered trademarks of Novell Inc. in the United States and other countries. Oracle® is a registered trademark of Oracle Corporation and/or its affiliates. Citrix®, Xen®, XenServer® and XenMotion® are either registered trademarks or trademarks of Citrix Systems, Inc. in the United States and/or other countries. VMware®, vMotion®, vCenter®, vCenter SRM™ and vSphere® are registered trademarks or trademarks of VMware, Inc. in the United States or other countries. IBM® is a registered trademark of International Business Machines Corporation.

2013 - 11

Rev. A04

# Contents

<b>1 About Your System.....</b>	<b>9</b>
Front-Panel Features And Indicators.....	9
LCD Panel Features.....	11
Home Screen.....	11
Setup Menu.....	12
View Menu.....	12
Hard-Drive Indicator Patterns.....	13
Back-Panel Features And Indicators.....	14
NIC Indicator Codes.....	15
Power Indicator Codes.....	15
Power Indicator Codes For Non-Redundant Power Supply.....	17
Other Information You May Need.....	18
<b>2 Using The System Setup And Boot Manager.....</b>	<b>19</b>
Choosing The System Boot Mode.....	19
Entering System Setup.....	20
Responding To Error Messages.....	20
Using The System Setup Navigation Keys.....	20
System Setup Options.....	21
System Setup Main Screen.....	21
System BIOS Screen.....	21
System Information Screen.....	21
Memory Settings Screen.....	22
Processor Settings Screen.....	22
SATA Settings Screen.....	24
Boot Settings Screen.....	24
Integrated Devices Screen.....	24
Serial Communications Screen.....	25
System Profile Settings Screen.....	26
System Security Screen.....	27
Miscellaneous Settings.....	28
System And Setup Password Features.....	28
Assigning A System And/Or Setup Password.....	29
Deleting Or Changing An Existing System And/Or Setup Password.....	29
Using Your System Password To Secure Your System.....	30
Operating With A Setup Password Enabled.....	30
Entering The UEFI Boot Manager.....	30
Using The Boot Manager Navigation Keys.....	31

Boot Manager Screen.....	31
UEFI Boot Menu.....	32
Embedded System Management.....	32
iDRAC Settings Utility.....	32
Entering The iDRAC Settings Utility.....	32
Changing The Thermal Settings.....	32

### **3 Installing System Components.....35**

Recommended Tools.....	35
Front Bezel (Optional).....	35
Installing The Front Bezel.....	35
Removing The Front Bezel.....	36
Opening And Closing The System.....	36
Opening The System.....	36
Closing The System.....	37
Inside The System.....	37
Cooling Shroud.....	39
Removing The Cooling Shroud.....	40
Installing The Cooling Shroud.....	41
System Memory.....	41
General Memory Module Guidelines.....	43
Mode-Specific Guidelines.....	43
Advanced ECC (Lockstep).....	43
Memory Optimized (Independent Channel) Mode.....	44
Memory Sparing.....	44
Memory Mirroring.....	44
Sample Memory Configurations.....	44
Removing Memory Modules.....	46
Installing Memory Modules.....	47
Hard Drives.....	48
Removing A 3.5 Inch Hard-Drive Blank.....	49
Installing A 3.5 Inch Hard-Drive Blank.....	49
Removing A Dual Slot Hard-Drive Blank.....	50
Installing A Dual Slot Hard-Drive Blank.....	51
Removing A Hot-Swap Hard Drive.....	51
Installing A Hot-Swap Hard Drive.....	52
Removing A 2.5 Inch Hard Drive From A 3.5 Inch Hard-Drive Adapter.....	53
Installing A 2.5 Inch Hard Drive Into A 3.5 Inch Hard-Drive Adapter.....	53
Removing A Hard Drive Or A Hard-Drive Adapter From A Hard-Drive Carrier.....	53
Installing A Hard Drive Or A Hard-Drive Adapter Into A Hard-Drive Carrier.....	55
Optical Drive (Optional).....	56
Removing The Optical Drive.....	56



Installing The Optical Drive.....	57
Cooling Fans.....	57
Removing A Cooling Fan.....	57
Installing A Cooling Fan.....	58
Internal USB Memory Key (Optional).....	59
Replacing the Internal USB Key.....	59
Expansion Cards And Expansion-Card Risers.....	60
Expansion-Card Installation Guidelines.....	60
Removing An Expansion Card.....	61
Installing An Expansion Card.....	63
Removing Expansion-Card Risers.....	64
Installing Expansion-Card Risers.....	65
iDRAC Ports Card (Optional).....	65
Removing The iDRAC Ports Card.....	66
Installing The iDRAC Ports Card.....	67
SD vFlash Card.....	68
Replacing An SD vFlash Card.....	68
Internal Dual SD Module.....	68
Removing The Internal Dual SD Module.....	69
Installing The Internal Dual SD Module.....	70
Internal SD Card.....	70
Removing An Internal SD Card.....	70
Installing An Internal SD Card.....	70
Integrated Storage Controller Card.....	71
Removing The Integrated Storage Controller.....	71
Installing The Integrated Storage Controller.....	72
Processors.....	73
Removing A Processor.....	73
Installing A Processor.....	75
Power Supplies.....	76
Removing An AC Power Supply.....	77
Installing An AC Power Supply.....	78
Wiring Instructions For A DC Power Supply.....	78
Removing A DC Power Supply.....	81
Installing A DC Power Supply.....	81
Removing The Power Supply Blank.....	82
Installing The Power Supply Blank.....	82
Removing The Power-Distribution And Power-Interposer Boards.....	83
Installing The Power-Distribution And Power-Interposer Boards.....	85
Removing A Non-Redundant Power Supply.....	86
Installing A Non-Redundant Power Supply.....	88
Removing The Redundant Power Supply Unit Divider.....	88

Installing The Redundant Power Supply Unit Divider.....	89
System Battery.....	90
Replacing The System Battery.....	90
Hard-Drive Backplane.....	91
Removing The Hard-Drive Backplane.....	91
Installing The Hard-Drive Backplane.....	94
Control Panel Assembly.....	95
Removing The Control-Panel Board.....	95
Installing The Control-Panel Board.....	96
Removing The Control Panel.....	96
Installing The Control Panel.....	97
System Board.....	97
Removing The System Board.....	98
Installing The System Board.....	99

#### **4 Troubleshooting Your System..... 101**

Safety First—For You And Your System.....	101
Troubleshooting System Startup Failure.....	101
Troubleshooting External Connections.....	101
Troubleshooting The Video Subsystem.....	101
Troubleshooting A USB Device.....	101
Troubleshooting A Serial I/O Device.....	102
Troubleshooting A NIC.....	102
Troubleshooting A Wet System.....	103
Troubleshooting A Damaged System.....	103
Troubleshooting The System Battery.....	104
Troubleshooting Power Supplies.....	104
Troubleshooting Cooling Problems.....	105
Troubleshooting Cooling Fans.....	105
Troubleshooting System Memory.....	105
Troubleshooting An Internal USB Key.....	106
Troubleshooting An SD Card.....	106
Troubleshooting An Optical Drive.....	107
Troubleshooting A Hard Drive.....	108
Troubleshooting A Storage Controller.....	108
Troubleshooting Expansion Cards.....	109
Troubleshooting Processors.....	110

#### **5 Using System Diagnostics..... 111**

Dell Online Diagnostics.....	111
Dell Embedded System Diagnostics.....	111
When To Use The Embedded System Diagnostics.....	111

Running The Embedded System Diagnostics.....	111
System Diagnostic Controls.....	112
<b>6 Jumpers And Connectors.....</b>	<b>113</b>
System Board Jumper Settings.....	113
System Board Connectors.....	114
Disabling A Forgotten Password.....	115
<b>7 Technical Specifications.....</b>	<b>117</b>
<b>8 System Messages.....</b>	<b>123</b>
LCD Messages.....	123
Viewing LCD Messages.....	123
Removing LCD Messages.....	123
System Error Messages.....	123
Warning Messages.....	139
Diagnostic Messages.....	139
Alert Messages.....	139
<b>9 Getting Help.....</b>	<b>141</b>
Contacting Dell.....	141



# About Your System

## Front-Panel Features And Indicators

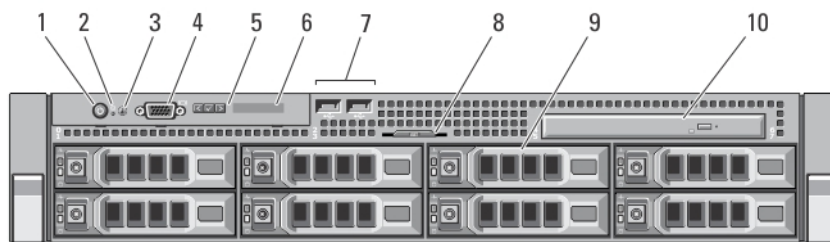

Figure 1. Front-Panel Features and Indicators

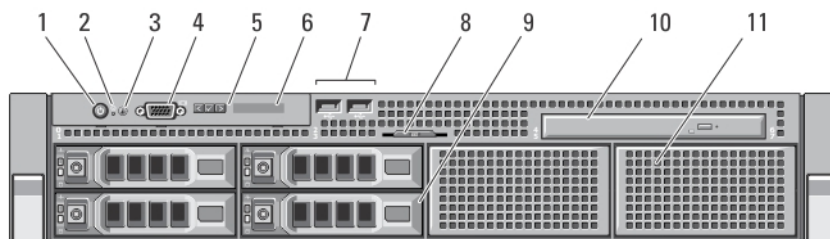











Figure 2. Front-Panel Features and Indicators for a Software RAID System

Item	Indicator, Button, or Connector	Icon	Description
1	Power-on indicator, power button		The power-on indicator lights when the system power is on. The power button controls the power supply output to the system.   <b>NOTE:</b> On ACPI-compliant operating systems, turning off the system using the power button causes the system to perform a graceful shutdown before power to the system is turned off.
2	NMI button		Used to troubleshoot software and device driver errors when using certain operating systems. This button can be pressed using the end of a paper clip.

Item	Indicator, Button, or Connector	Icon	Description
3	System identification button		<p>Use this button only if directed to do so by qualified support personnel or by the operating system's documentation.</p> <p>The identification buttons on the front and back panels can be used to locate a particular system within a rack. When one of these buttons is pushed, the LCD panel on the front and the system status indicator on the back flashes blue until one of the buttons is pushed again. Press to toggle the system ID on and off. If the system hangs during POST, press and hold the system ID button for more than five seconds to enter BIOS progress mode. To reset the iDRAC (if not disabled in F2 iDRAC setup) press and hold for more than 15 seconds.</p>
4	Video connector		Connects a VGA display to the system.
5	LCD menu buttons		Allows you to navigate the control panel LCD menu.
6	LCD panel		<p>Displays system ID, status information, and system error messages. The LCD lights blue during normal system operation. The LCD lights amber when the system needs attention, and the LCD panel displays an error code followed by descriptive text.</p> <p> <b>NOTE:</b> If the system is connected to AC power and an error is detected, the LCD lights amber regardless of whether the system is turned on.</p>
7	USB connectors (2)		Allows you to connect USB devices to the system. The ports are USB 2.0 compliant.
8	Information tag		A slide-out label panel, which allows you to record system information, such as Service Tag, NIC, MAC address, and so on as per your need.
9	Hard drives (8)		<ul style="list-style-type: none"> <li>Up to eight 2.5 inch or 3.5 inch hot-swappable hard drives.</li> <li>Up to four 2.5 inch or 3.5 inch hot-swappable hard drives on software RAID systems.</li> </ul>
10	Optical drive (optional)		<p>One optional SATA DVD-ROM drive or DVD+/-RW drive.</p> <p> <b>NOTE:</b> DVD devices are data only.</p>
11	Dual slot hard-drive blanks (2)		<p>Hard-drive blanks for the empty hard-drive slots.</p> <p> <b>NOTE:</b> Dual slot hard-drive blanks are available only on software RAID systems. The blank hard-drive slots are not available for software RAID.</p>

## LCD Panel Features

The system's LCD panel provides system information and status and error messages to indicate when the system is operating correctly or when the system needs attention. See LCD Error Messages for information about specific error codes.

- The LCD backlight lights blue during normal operating conditions and lights amber to indicate an error condition.
- The LCD backlight is off when the system is in standby mode and can be turned on by pressing either the Select, Left, or Right button on the LCD panel.
- The LCD backlight remains off if LCD messaging is turned off through the iDRAC utility, the LCD panel, or other tools.

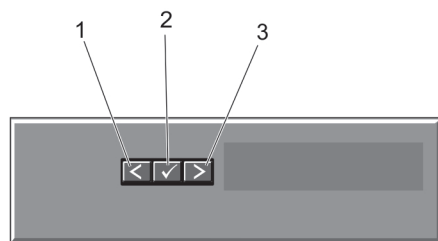



Figure 3. LCD Panel Features

Item	Button	Description
1	Left	Moves the cursor back in one-step increments.
2	Select	Selects the menu item highlighted by the cursor.
3	Right	Moves the cursor forward in one-step increments. During message scrolling: <ul style="list-style-type: none"><li>• Press once to increase scrolling speed</li><li>• Press again to stop</li><li>• Press again to return to default scrolling speed</li><li>• Press again to repeat the cycle</li></ul>

## Home Screen

The Home screen displays user-configurable information about the system. This screen is displayed during normal system operation when there are no status messages or errors. When the system is in standby mode, the LCD backlight turns off after five minutes of inactivity if there are no error messages. Press one of the three navigation buttons (Select, Left, or Right) to view the Home screen.

To navigate to the Home screen from another menu, continue to select the up arrow  until the Home icon  is displayed, and then select the Home icon.

From the Home screen, press the Select button to enter the main menu.

## Setup Menu

 **NOTE:** When you select an option in the Setup menu, you must confirm the option before proceeding to the next action.

Option	Description
iDRAC	Select <b>DHCP</b> or <b>Static IP</b> to configure the network mode. If <b>Static IP</b> is selected, the available fields are <b>IP</b> , <b>Subnet (Sub)</b> , and <b>Gateway (Gtw)</b> . Select <b>Setup DNS</b> to enable DNS and to view domain addresses. Two separate DNS entries are available.
Set error	Select <b>SEL</b> to display LCD error messages in a format that matches the IPMI description in the SEL. This is useful when trying to match an LCD message with an SEL entry. Select <b>Simple</b> to display LCD error messages in a simplified user-friendly description. See System Error Messages for a list of messages in this format.
Set home	Select the default information to be displayed on the LCD Home screen. See <b>View Menu</b> to see the options and option items that can be set as the default on the Home screen.

## View Menu

 **NOTE:** When you select an option in the View menu, you must confirm the option before proceeding to the next action.

Option	Description
iDRAC IP	Displays the <b>IPv4</b> or <b>IPv6</b> addresses for the iDRAC7. Addresses include <b>DNS (Primary and Secondary)</b> , <b>Gateway</b> , <b>IP</b> , and <b>Subnet</b> (IPv6 does not have Subnet).
MAC	Displays the MAC addresses for <b>iDRAC</b> , <b>iSCSI</b> , or <b>Network</b> devices.
Name	Displays the name of the <b>Host</b> , <b>Model</b> , or <b>User String</b> for the system
Number	Displays the <b>Asset tag</b> or the <b>Service tag</b> for the system.
Power	Displays the power output of the system in BTU/hr or Watts. The display format can be configured in the <b>Set home</b> submenu of the <b>Setup</b> menu.
Temperature	Displays the temperature of the system in Celsius or Fahrenheit. The display format can be configured in the <b>Set home</b> submenu of the <b>Setup</b> menu.



# Hard-Drive Indicator Patterns



**Figure 4. Hard-Drive Indicators**

1. hard-drive activity indicator (green)
2. hard-drive status indicator (green and amber)

 **NOTE:** If the hard drive is in Advanced Host Controller Interface (AHCI) mode, the status indicator (on the right side) does not function and remains off.

Drive-Status Indicator Pattern (RAID Only)	Condition
Blinks green two times per second	Identifying drive or preparing for removal
Off	Drive ready for insertion or removal

 **NOTE:** The drive status indicator remains off until all hard drives are initialized after the system is turned on. Drives are not ready for insertion or removal during this time.

Blinks green, amber, and off	Predicted drive failure
Blinks amber four times per second	Drive failed
Blinks green slowly	Drive rebuilding
Steady green	Drive online
Blinks green three seconds, amber three seconds, and off six seconds	Rebuild aborted

# Back-Panel Features And Indicators

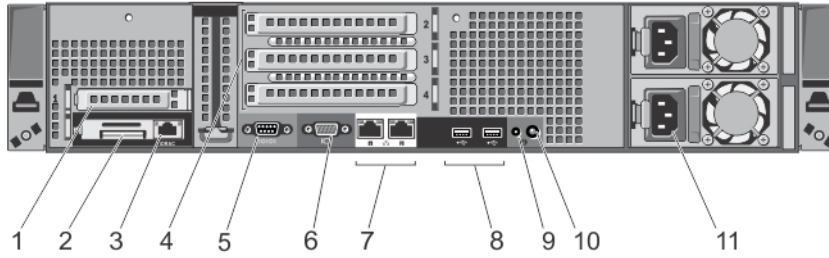

Figure 5. Back-Panel Features and Indicators—Redundant Power Supply Unit Chassis

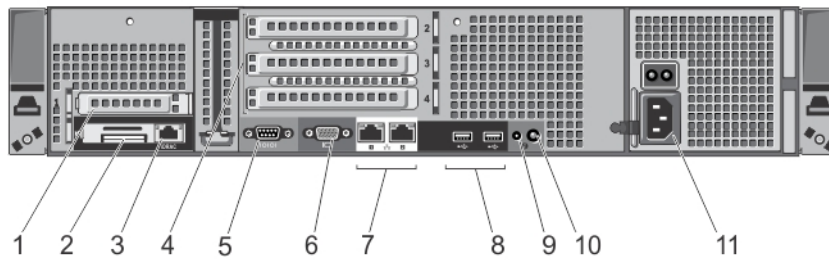





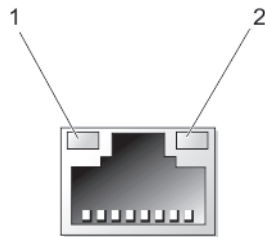

Figure 6. Back-Panel Features and Indicators—Non-Redundant Power Supply Unit Chassis

Item	Indicator, Button, or Connector	Icon	Description
1	PCIe expansion card slot 1		Connects a PCI Express expansion card.
2	vFlash media card slot (Optional)		Allows you to insert a vFlash media card.
3	iDRAC port (Optional)		Dedicated management port for the iDRAC Ports Card.
4	PCIe expansion card slots (3)		Connects a PCI Express expansion card.
5	Serial connector		Connects a serial device to the system.
6	Video connector		Connects a VGA display to the system.
7	Ethernet connectors (2)		Integrated 10/100/1000 Mbps NIC connector Integrated 100 Mbps/1 Gbps/10 Gbps SFP+ connector
8	USB connectors (2)		Connect USB devices to the system. The ports are USB 2.0-compliant.
9	System identification connector		Connects the optional system status indicator assembly through the optional cable management arm.
10	System identification button		The identification buttons on the front and back panels can be used to locate a particular system within a rack. When one of these buttons is pushed, the LCD panel on

Item	Indicator, Button, or Connector	Icon	Description
			the front and the system status indicator on the back blink until one of the buttons is pushed again. Press to toggle the system ID on and off. If the system hangs during POST, press and hold the system ID button for more than five seconds to enter BIOS progress mode. To reset the iDRAC (if not disabled in System Setup) press and hold for more than 15 seconds.
11	Power supply		<p><b>AC</b> 495 W, 750 W, 1100 W or 550 W (non-redundant),</p> <p><b>Or</b></p> <p><b>DC</b> 750 W or 1100 W</p>

## NIC Indicator Codes



**Figure 7. NIC Indicator**

1. link indicator
2. activity indicator

Indicator	Indicator Code
<b>Link and activity indicators are off</b>	The NIC is not connected to the network.
<b>Link indicator is green</b>	The NIC is connected to a valid network at its maximum port speed (1 Gbps or 10 Gbps).
<b>Link indicator is amber</b>	The NIC is connected to a valid network at less than its maximum port speed.
<b>Activity indicator is blinking green</b>	Network data is being sent or received.

## Power Indicator Codes

Each AC power supply has an illuminated translucent handle and each DC power supply (when available) has an LED that serves as an indicator to show whether power is present or whether a power fault has occurred.

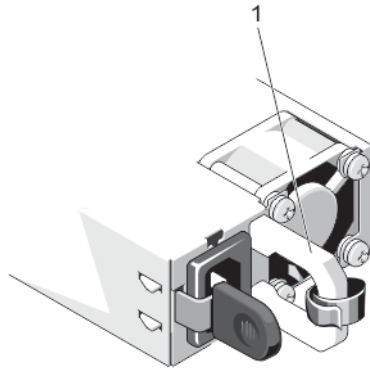

**Figure 8. AC Power Supply Status Indicator**

1. AC power supply status indicator/handle

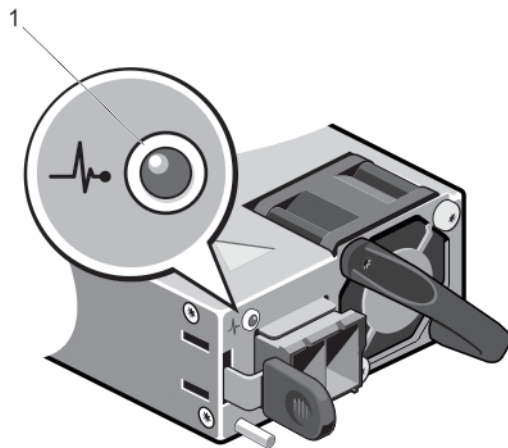

**Figure 9. DC Power Supply Status Indicator**

1. DC power supply status indicator

Power Indicator Pattern	Condition
Not lit	Power is not connected.
Green	The handle/LED indicator lights green indicating that a valid power source is connected to the power supply and that the power supply is operational.
Flashing amber	Indicates a problem with the power supply.

**⚠ CAUTION: When correcting a power supply mismatch, replace only the power supply with the flashing indicator. Swapping the opposite power supply to make a matched pair can result in an error condition and unexpected system shutdown. To change from a High Output configuration to a Low Output configuration or vice versa, you must power down the system.**

Power Indicator Pattern	Condition
	<p>⚠ CAUTION: AC power supplies support both 220 V and 110 V input voltages with the exception of Titanium power supplies, which support only 220 V. When two identical power supplies receive different input voltages, they can output different wattages, and trigger a mismatch.</p> <p>⚠ CAUTION: If two power supplies are used, they must be of the same type and have the same maximum output power.</p> <p>⚠ CAUTION: Combining AC and DC power supplies is not supported and triggers a mismatch.</p>
Flashing green	<p>When hot-adding a power supply, this indicates that the power supply is mismatched with the other power supply (in terms of efficiency, feature set, health status, and supported voltage). Replace the power supply that has the flashing indicator with a power supply that matches the capacity of the other installed power supply.</p>

## Power Indicator Codes For Non-Redundant Power Supply

The non-redundant power supply has a status indicator and a self-diagnostic button. The self-diagnostic button is used to perform a quick health check on the non-redundant power supply of the system.

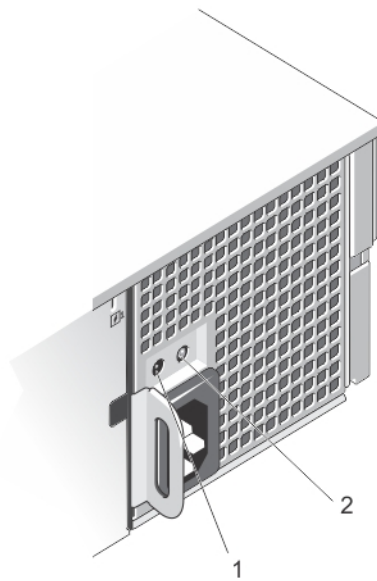

Figure 10. Non-Redundant AC Power Supply Status Indicator and Self-Diagnostic Button

1. self-diagnostic button
2. non-redundant AC power supply status indicator

Diagnostic Indicator Pattern	Condition
Not lit	Power is not connected or power supply is faulty.

**Diagnostic Indicator    Condition  
Pattern**

**Green**                    A valid power source is connected to the power supply and the power supply is operational.

## Other Information You May Need

 **WARNING:** See the safety and regulatory information that shipped with your system. Warranty information may be included within this document or as a separate document.

- The *Getting Started Guide* provides an overview of setting up your system, and technical specifications. This document is available online at [www.dell.com/support/manuals](http://www.dell.com/support/manuals).
- The rack documentation included with your rack solution describes how to install your system into a rack, if required.
- Any media that ships with your system that provides documentation and tools for configuring and managing your system, including those pertaining to the operating system, system management software, system updates, and system components that you purchased with your system.
- For the full name of an abbreviation or acronym used in this document, see the Glossary at [www.dell.com/support/manuals](http://www.dell.com/support/manuals).

 **NOTE:** Always check for updates on [www.dell.com/support/manuals](http://www.dell.com/support/manuals) and read the updates first because they often supersede information in other documents.

# Using The System Setup And Boot Manager

System Setup enables you to manage your system hardware and specify BIOS-level options.

The following keystrokes provide access to system features during startup:

Keystroke	Description
<F2>	Enters the System Setup.
<F10>	Enters System Services, which opens the Dell Lifecycle Controller 2 (LC2). The Dell LC2 supports systems management features such as operating system deployment, hardware diagnostics, firmware updates, and platform configuration, using a graphical user interface. The exact LC2 feature set is determined by the iDRAC license purchased. For more information, see the Dell LC2 documentation.
<F11>	Enters the BIOS Boot Manager or the Unified Extensible Firmware Interface (UEFI) Boot Manager, depending on the system's boot configuration
<F12>	Starts Preboot Execution Environment (PXE) boot.

From the System Setup, you can:

- Change the NVRAM settings after you add or remove hardware
- View the system hardware configuration
- Enable or disable integrated devices
- Set performance and power management thresholds
- Manage system security

You can access the System Setup using the:

- Standard graphical browser, which is enabled by default
- Text browser, which is enabled using **Console Redirection**

To enable **Console Redirection**, in **System Setup**, select **System BIOS** → **Serial Communication screen** → **Serial Communication**, select **On with Console Redirection**.

 **NOTE:** By default, help text for the selected field is displayed in the graphical browser. To view the help text in the text browser, press <F1>.

## Choosing The System Boot Mode

System Setup enables you to specify the boot mode for installing your operating system:

- BIOS boot mode (the default) is the standard BIOS-level boot interface.

- UEFI boot mode is an enhanced 64-bit boot interface based on Unified Extensible Firmware Interface (UEFI) specifications that overlays the system BIOS.

You must select the boot mode in the **Boot Mode** field of the **Boot Settings** screen of System Setup. Once you specify the boot mode, the system boots in the specified boot mode and you then proceed to install your operating system from that mode. Thereafter, you must boot the system in the same boot mode (BIOS or UEFI) to access the installed operating system. Trying to boot the operating system from the other boot mode will cause the system to halt at startup.

 **NOTE:** Operating systems must be UEFI-compatible to be installed from the UEFI boot mode. DOS and 32-bit operating systems do not support UEFI and can only be installed from the BIOS boot mode.

 **NOTE:** For the latest information on supported operating systems, go to [dell.com/ossupport](http://dell.com/ossupport).

## Entering System Setup

1. Turn on or restart your system.
2. Press **<F2>** immediately after you see the following message:  

```
<F2> = System Setup
```

If your operating system begins to load before you press **<F2>**, allow the system to finish booting, and then restart your system and try again.

## Responding To Error Messages

If an error message is displayed while the system is booting, make a note of the message. For more information, see System Error Messages.

 **NOTE:** After installing a memory upgrade, it is normal for your system to display a message the first time you start your system.

## Using The System Setup Navigation Keys

Keys	Action
<b>Up arrow</b>	Moves to the previous field.
<b>Down arrow</b>	Moves to the next field.
<b>&lt;Enter&gt;</b>	Allows you to type in a value in the selected field (if applicable) or follow the link in the field.
<b>Spacebar</b>	Expands or collapses a drop-down menu, if applicable.
<b>&lt;Tab&gt;</b>	Moves to the next focus area.
	 <b>NOTE:</b> For the standard graphics browser only.
<b>&lt;Esc&gt;</b>	Moves to the previous page till you view the main screen. Pressing <b>&lt;Esc&gt;</b> in the main screen displays a message that prompts you to save any unsaved changes and restarts the system.
<b>&lt;F1&gt;</b>	Displays the System Setup help file.

 **NOTE:** For most of the options, any changes that you make are recorded but do not take effect until you restart the system.



# System Setup Options

## System Setup Main Screen

 **NOTE:** Press <Alt><F> to reset the BIOS or UEFI settings to their default settings.

Menu Item	Description
<b>System BIOS</b>	This option is used to view and configure BIOS settings.
<b>iDRAC Settings</b>	This option is used to view and configure iDRAC settings.
<b>Device Settings</b>	This option is used to view and configure device settings.

## System BIOS Screen

 **NOTE:** The options for System Setup change based on the system configuration.

 **NOTE:** System Setup defaults are listed under their respective options in the following sections, where applicable.



Menu Item	Description
<b>System Information</b>	Displays information about the system such as the system model name, BIOS version, Service Tag, and so on.
<b>Memory Settings</b>	Displays information and options related to installed memory.
<b>Processor Settings</b>	Displays information and options related to the processor such as speed, cache size, and so on.
<b>SATA Settings</b>	Displays options to enable or disable the integrated SATA controller and ports.
<b>Boot Settings</b>	Displays options to specify the boot mode (BIOS or UEFI). Enables you to modify UEFI and BIOS boot settings.
<b>Integrated Devices</b>	Displays options to enable or disable integrated device controllers and ports, and to specify related features and options.
<b>Serial Communication</b>	Displays options to enable or disable the serial ports and specify related features and options.
<b>System Profile Settings</b>	Displays options to change the processor power management settings, memory frequency, and so on.
<b>System Security</b>	Displays options to configure the system security settings like, system password, setup password, TPM security, and so on. It also enables or disables the power and NMI buttons on the system.
<b>Miscellaneous Settings</b>	Displays options to change the system date, time, and so on.

## System Information Screen

Menu Item	Description
<b>System Model Name</b>	Displays the system model name.



Menu Item	Description
<b>System BIOS Version</b>	Displays the BIOS version installed on the system.
<b>System Service Tag</b>	Displays the system Service Tag.
<b>System Manufacturer</b>	Displays the name of system manufacturer.
<b>System Manufacturer Contact Information</b>	Displays the contact information of the system manufacturer.

## Memory Settings Screen

Menu Item	Description
<b>System Memory Size</b>	Displays the amount of memory installed in the system.
<b>System Memory Type</b>	Displays the type of memory installed in the system.
<b>System Memory Speed</b>	Displays the system memory speed.
<b>System Memory Voltage</b>	Displays the system memory voltage.
<b>Video Memory</b>	Displays the amount of video memory.
<b>System Memory Testing</b>	Specifies whether system memory tests are run during system boot. Options are <b>Enabled</b> and <b>Disabled</b> . By default, the <b>System Memory Testing</b> option is set to <b>Disabled</b> .
<b>Memory Operating Mode</b>	Specifies the memory operating mode. The options available depending on the memory configuration of your system are <b>Optimizer Mode</b> , <b>Advanced ECC Mode</b> , <b>Mirror Mode</b> , <b>Spare Mode</b> , <b>Spare with Advanced ECC Mode</b> , and <b>Dell Fault Resilient Mode</b> . By default, the <b>Memory Operating Mode</b> option is set to <b>Optimizer Mode</b> . <ul style="list-style-type: none"> <li> <b>NOTE:</b> The Memory Operating Mode can have different defaults and available options based on the memory configuration.</li> <li> <b>NOTE:</b> The Dell Fault Resilient Mode establishes an area of memory that is fault resilient. This mode can be used by an operating system that supports the feature to load critical applications or enables the operating system kernel to maximize system availability.</li> </ul>
<b>Node Interleaving</b>	If this field is <b>Enabled</b> , memory interleaving is supported if a symmetric memory configuration is installed. If <b>Disabled</b> , the system supports Non-Uniform Memory architecture (NUMA) (asymmetric) memory configurations. By default, <b>Node Interleaving</b> option is set to <b>Disabled</b> .

## Processor Settings Screen





Menu Item	Description
<b>Logical Processor</b>	Allows you to enable or disable logical processors and display the number of logical processors. If the <b>Logical Processor</b> option is set to <b>Enabled</b> , the BIOS displays all the logical processors. If this option is set to <b>Disabled</b> , the BIOS only displays one logical processor per core. By default, the <b>Logical Processor</b> option is set to <b>Enabled</b> .
<b>QPI Speed</b>	Allows you to set the QuickPath Interconnect data rate settings. By default, the <b>QPI Speed</b> option is set to <b>Maximum data rate</b> .

Menu Item	Description
	 <b>NOTE:</b> The QPI speed option displays only when both the processors are installed.
<b>Alternate RTID (Requestor Transaction ID) Setting</b>	Allows you to allocate more RTIDs to the remote socket increasing cache performance between the sockets or work in normal mode for NUMA. By default, the <b>Alternate RTID (Requestor Transaction ID) Setting</b> is set to <b>Disabled</b> .
<b>Virtualization Technology</b>	Allows you to enable or disable the additional hardware capabilities provided for virtualization. By default, the <b>Virtualization Technology</b> option is set to <b>Enabled</b> .
<b>Adjacent Cache Line Prefetch</b>	Allows you to optimize the system for applications that require high utilization of sequential memory access. By default, the <b>Adjacent Cache Line Prefetch</b> option is set to <b>Enabled</b> . You can disable this option for applications that require high utilization of random memory access.
<b>Hardware Prefetcher</b>	Allows you to enable or disable hardware prefetcher. By default, the <b>Hardware Prefetcher</b> option is set to <b>Enabled</b> .
<b>DCU Streamer Prefetcher</b>	Allows you to enable or disable Data Cache Unit streamer prefetcher. By default, the <b>DCU Streamer Prefetcher</b> option is set to <b>Enabled</b> .
<b>DCU IP Prefetcher</b>	Allows you to enable or disable Data Cache Unit IP prefetcher. By default, the <b>DCU IP Prefetcher</b> option is set to <b>Enabled</b> .
<b>Execute Disable</b>	Allows you enable or disable execute disable memory protection technology. By default, the <b>Execute Disable</b> option is set to <b>Enabled</b> .
<b>Logical Processor Idling</b>	Allows you to enable or disable the OS capability to put logical processors in the idling state in order to reduce power consumption. By default, the option is set to <b>Disabled</b> .
<b>Number of Cores per Processor</b>	Allows you to control the number of enabled cores in each processor. By default, the <b>Number of Cores per Processor</b> option is set to <b>All</b> .
<b>Processor 64-bit Support</b>	Specifies if the processor(s) support 64-bit extensions.
<b>Processor Core Speed</b>	Displays the maximum core frequency of the processor.
<b>Processor Bus Speed</b>	Displays the bus speed of the processors.   <b>NOTE:</b> The processor bus speed option displays only when both the processors are installed.
<b>Processor 1</b>	 <b>NOTE:</b> The following settings are displayed for each processor installed in the system.
<b>Family-Model-Stepping</b>	Displays the family, model and stepping of the processor as defined by Intel.
<b>Brand</b>	Displays the brand name reported by the processor.
<b>Level 2 Cache</b>	Displays the total L2 cache.
<b>Level 3 Cache</b>	Displays the total L3 cache.
<b>Number of Cores</b>	Displays the number of cores per processor.

## SATA Settings Screen



Menu Item	Description
Embedded SATA	Allows the embedded SATA to be set to <b>Off</b> , <b>ATA</b> , <b>AHCI</b> , or <b>RAID</b> modes. By default, the <b>Embedded SATA</b> option is set to <b>AHCI</b> .
Port E	Auto enables BIOS support for the device attached to SATA port E. Off disables BIOS support for the device. By default, Port E is set to <b>Auto</b> .

## Boot Settings Screen

Menu Item	Description
Boot Mode	<p>Allows you to set the boot mode of the system.</p> <p> <b>CAUTION: Switching the boot mode may prevent the system from booting if the operating system is not installed in the same boot mode.</b></p> <p>If the operating system supports UEFI, you can set this option to UEFI. Setting this field to BIOS allows compatibility with non-UEFI operating systems. By default, the <b>Boot Mode</b> option is set to <b>BIOS</b>.</p> <p> <b>NOTE:</b> Setting this field to UEFI disables BIOS Boot Settings menu. Setting this field to BIOS disables the UEFI Boot Settings menu.</p>
Boot Sequence Retry	Allows you to enable or disable the boot sequence retry feature. If this field is enabled and the system fails to boot, the system reattempts the boot sequence after 30 seconds. By default, the <b>Boot Sequence Retry</b> option is set to <b>Disabled</b> .
BIOS Boot Settings	<p>Allows you to enable or disable BIOS Boot options.</p> <p> <b>NOTE:</b> This option is enabled only if the boot mode is BIOS.</p>
UEFI Boot Settings	<p>Allows you to enable or disable UEFI Boot options. The Boot options include <b>IPv4 PXE</b> and <b>IPv6 PXE</b>. By default, the <b>UEFI PXE boot protocol</b> is set to <b>IPv4</b>.</p> <p> <b>NOTE:</b> This option is enabled only if the boot mode is UEFI.</p>
One-Time Boot	Allows you to enable or disable a one-time boot from a selected device.

## Integrated Devices Screen

Menu Item	Description
Integrated RAID Controller	Allows you to enable or disable the integrated RAID controller. By default, the <b>Integrated RAID Controller</b> option is set to <b>Enabled</b> .
User Accessible USB Ports	Allows you enable or disable the user accessible USB ports. Selecting <b>Only Back Ports On</b> disables the front USB ports and selecting <b>All Ports Off</b> disables both front and back USB ports. By default, the <b>User Accessible USB Ports</b> option is set to <b>All Ports On</b> .
Internal USB Port	Allows you to enable or disable the internal USB port. By default, the <b>Internal USB Port</b> option is set to <b>On</b> .



Menu Item	Description
<b>Internal SD Card Port</b>	Enables or disables the system's internal SD card port. By default, <b>Internal SD Card Port</b> option is set to <b>On</b> .   <b>NOTE:</b> This option is displayed only if IDSDM is installed on the system board.
<b>Internal SD Card Redundancy</b>	If set to <b>Mirror</b> mode, data is written on both SD cards. If any one of the SD card fails, data is written to the active SD card. Data from this card is copied to the replacement SD card at the next boot. By default, <b>Internal SD Card Redundancy</b> option is set to <b>Mirror</b> .   <b>NOTE:</b> This option is displayed only if IDSDM is installed on the system board.
<b>Integrated Network Card 1</b>	Allows you to enable or disable the integrated network card 1. By default, the <b>Integrated Network Card 1</b> option is set to <b>Enabled</b> .
<b>OS Watchdog Timer</b>	Allows you to enable or disable the OS watchdog timer. When this field is enabled, the operating system initializes the timer and the OS watchdog timer helps in recovering the operating system. By default, the <b>OS Watchdog Timer</b> option is set to <b>Disabled</b> .
<b>Embedded Video Controller</b>	Allows you to enable or disable the <b>Embedded Video Controller</b> . By default, the embedded video controller is <b>Enabled</b> .
<b>SR-IOV Global Enable</b>	Allows you to enable or disable the BIOS configuration of Single Root I/O Virtualization (SR-IOV) devices. By default, the <b>SR-IOV Global Enable</b> option is set to <b>Disabled</b> .
<b>Slot Disablement</b>	Allows you to enable or disable available PCIe slots on your system. The <b>Slot Disablement</b> feature controls the configuration of PCIe cards installed in the specified slot.   <b>CAUTION:</b> Slot disablement must be used only when the installed peripheral card is preventing booting into the Operating System or causing delays in system startup. If the slot is disabled, both the Option ROM and UEFI driver are disabled.
<b>Memory Mapped I/O above 4 GB</b>	Allows you to enable support for PCIe devices that require large amounts of memory. By default, the option is set to <b>Enabled</b> .

## Serial Communications Screen

Menu Item	Description
<b>Serial Communication</b>	Allows you to select serial communication devices (Serial Device 1 and Serial Device 2) in the BIOS. BIOS console redirection can also be enabled and the port address used can be specified. By default, <b>Serial Communication</b> option is set to <b>On without Console Redirection</b> .
<b>Serial Port Address</b>	Allows you to set the port address for serial devices. By default, the <b>Serial Port Address</b> option is set to <b>Serial Device 1=COM2, Serial Device 2=COM1</b> .   <b>NOTE:</b> Only Serial Device 2 can be used for Serial Over LAN (SOL). To use console redirection by SOL, configure the same port address for console redirection and the serial device.
<b>External Serial Connector</b>	Allows you to associate the external serial connector to serial device 1, serial device 2, or remote access device. By default, the <b>External Serial Connector</b> option is set to <b>Serial Device1</b> .



Menu Item	Description
	 <b>NOTE:</b> Only Serial Device 2 can be used for SOL. To use console redirection by SOL, configure the same port address for console redirection and the serial device.
<b>Failsafe Baud Rate</b>	Displays the failsafe baud rate for console redirection. The BIOS attempts to determine the baud rate automatically. This failsafe baud rate is used only if the attempt fails and the value must not be changed. By default, the <b>Failsafe Baud Rate</b> option is set to <b>115200</b> .
<b>Remote Terminal Type</b>	Allows you to set the remote console terminal type. By default, the <b>Remote Terminal Type</b> option is set to <b>VT 100/VT 220</b> .
<b>Redirection After Boot</b>	Allows you to enable or disable to the BIOS console redirection when the operating system is loaded. By default, the <b>Redirection After Boot</b> option is set to <b>Enabled</b> .

## System Profile Settings Screen

Menu Item	Description
<b>System Profile</b>	<p>Allows you to set the system profile. If you set the <b>System Profile</b> option to a mode other than <b>Custom</b>, the BIOS automatically sets the rest of the options. You can only change the rest of the options if the mode is set to <b>Custom</b>. By default, the <b>System Profile</b> option is set to <b>Performance Per Watt Optimized (DAPC)</b>. DAPC is Dell Active Power Controller.</p> <p>  <b>NOTE:</b> The following parameters are available only when the <b>System Profile</b> is set to <b>Custom</b>.         </p>
<b>CPU Power Management</b>	Allows you to set the CPU power management. By default, the <b>CPU Power Management</b> option is set to <b>System DBPM (DAPC)</b> . DBPM is Demand-Based Power Management.
<b>Memory Frequency</b>	Allows you to set the memory frequency. By default, the <b>Memory Frequency</b> option is set to <b>Maximum Performance</b> .
<b>Turbo Boost</b>	Allows you to enable or disable the processor to operate in turbo boost mode. By default, the <b>Turbo Boost</b> option is set to <b>Enabled</b> .
<b>C1E</b>	Allows you to enable or disable the processor to switch to a minimum performance state when it is idle. By default, the <b>C1E</b> option is set to <b>Enabled</b> .
<b>C States</b>	Allows you to enable or disable the processor to operate in all available power states. By default, the <b>C States</b> option is set to <b>Enabled</b> .
<b>Monitor/Mwait</b>	<p>Allows you to enable Monitor/Mwait instructions in the processor. By default, the Monitor/Mwait option is set to <b>Enabled</b> for all system profiles, except <b>Custom</b>.</p> <p>  <b>NOTE:</b> This option can be disabled only if the <b>C States</b> option in <b>Custom</b> mode is disabled.         </p> <p>  <b>NOTE:</b> When <b>C States</b> is enabled in <b>Custom</b> mode, changing the Monitor/Mwait setting does not impact system power/performance.         </p>
<b>Memory Patrol Scrub</b>	Allows you to set the memory patrol scrub frequency. By default, the <b>Memory Patrol Scrub</b> option is set to <b>Standard</b> .
<b>Memory Refresh Rate</b>	Allows you to set the memory refresh rate. By default, the <b>Memory Refresh Rate</b> option is set to <b>1x</b> .

Menu Item	Description
<b>Memory Operating Voltage</b>	Allows you to set the DIMM voltage selection. When set to <b>Auto</b> , the system automatically sets the system voltage to the optimal setting based on the DIMM capacity and the number of DIMMs installed. By default, the <b>Memory Operating Voltage</b> option is set to <b>Auto</b> .
<b>Collaborative CPU Performance Control</b>	When set to enabled, the CPU power management is controlled by the OS DBPM and the System DBPM (DAPC). By default, the option is set to <b>Disabled</b>

## System Security Screen

Menu Item	Description
<b>Intel AES-NI</b>	The <b>Intel AES-NI</b> option improves the speed of applications by performing encryption and decryption using the Advanced Encryption Standard Instruction Set and is set to <b>Enabled</b> by default.
<b>System Password</b>	Allows you to set the system password. This option is set to <b>Enabled</b> by default and is read-only if the password jumper is not installed in the system.
<b>Setup Password</b>	Allows you to set the setup password. This option is read-only if the password jumper is not installed in the system.
<b>Password Status</b>	Allows you to lock the system password. By default, the <b>Password Status</b> option is set to <b>Unlocked</b> .
<b>TPM Security</b>	Allows you to control the reporting mode of the Trusted Platform Module (TPM). By default, the <b>TPM Security</b> option is set to <b>Off</b> . You can only modify the TPM Status, TPM Activation , and Intel TXT fields if the <b>TPM Status</b> field is set to either <b>On with Pre-boot Measurements</b> or <b>On without Pre-boot Measurements</b> .
<b>TPM Activation</b>	Allows you to change the operational state of the TPM. By default, the <b>TPM Activation</b> option is set to <b>No Change</b> .
<b>TPM Status</b>	Displays the TPM status.
<b>TPM Clear</b>	<p> <b>CAUTION: Clearing the TPM results in loss of all keys in the TPM. The loss of TPM keys may affect booting to the operating system.</b></p> <p>Allows you to clear all the contents of the TPM. By default, the <b>TPM Clear</b> option is set to <b>No</b>.</p>
<b>Intel TXT</b>	Allows you enable or disable Intel Trusted Execution Technology. To enable <b>Intel TXT</b> , Virtualization Technology must be enabled and TPM Security must be <b>Enabled</b> with Pre-boot measurements. By default, the <b>Intel TXT</b> option is set to <b>Off</b> .
<b>BIOS Update Control</b>	<p>Allows you to update the BIOS using either DOS or UEFI shell-based flash utilities. For environments that do not require local BIOS updates, it is recommended to set this field to <b>Disabled</b>. By default, the <b>BIOS Update Control</b> option is set to <b>Unlocked</b>.</p> <p> <b>NOTE:</b> BIOS updates using Dell Update Package are not affected by this option.</p>
<b>Power Button</b>	Allows you to enable or disable the power button on the front of the system. By default, the <b>Power Button</b> option is set to <b>Enabled</b> .
<b>NMI Button</b>	Allows you to enable or disable the NMI button on the front of the system. By default, the <b>NMI Button</b> option is set to <b>Disabled</b> .

Menu Item	Description
<b>AC Power Recovery</b>	Allows you to set how the system reacts after AC power is restored to the system. By default, the <b>AC Power Recovery</b> option is set to <b>Last</b> .
<b>AC Power Recovery Delay</b>	Allows you to set how the system supports staggering of power up after AC power is restored to the system. By default, the <b>AC Power Recovery Delay</b> option is set to <b>Immediate</b> .
<b>User Defined Delay (60s to 240s)</b>	Allows you to set the <b>User Defined Delay</b> when the <b>User Defined</b> option for <b>AC Power Recovery Delay</b> is selected.

## Miscellaneous Settings

Menu Item	Description
<b>System Time</b>	Allows you to set the time on the system.
<b>System Date</b>	Allows you to set the date on the system.
<b>Asset Tag</b>	Displays the asset tag and allows you to modify it for security and tracking purposes.
<b>Keyboard NumLock</b>	Allows you to set whether the system boots with the NumLock enabled or disabled. By default the <b>Keyboard NumLock</b> is set to <b>On</b> .  <b>NOTE:</b> This field does not apply to 84-key keyboards.
<b>Report Keyboard Errors</b>	Allows you to set whether keyboard-related error messages are reported during system boot. By default, the <b>Report Keyboard Errors</b> field is set to <b>Report</b> .
<b>F1/F2 Prompt on Error</b>	Allows you to enable or disable the F1/F2 prompt on error. By default, <b>F1/F2 Prompt on Error</b> is set to <b>Enabled</b> .
<b>In-System Characterization</b>	This field enables or disables <b>In-System Characterization</b> . By default, <b>In-System Characterization</b> is set to <b>Enabled</b> .

## System And Setup Password Features

You can create a system password and a setup password to secure your system. To enable creation of the system and setup password, the password jumper must be set to enabled. For more information on the password jumper settings, see System Board Jumper Settings.

<b>System password</b>	This is the password that you must enter before you can boot your system.
<b>Setup password</b>	This is the password that you must enter to access and make changes to the BIOS or UEFI settings of your system.

 **CAUTION:** The password features provide a basic level of security for the data on your system.

 **CAUTION:** Anyone can access the data stored on your system if the system is running and unattended.

 **NOTE:** Your system is shipped with the system and setup password feature disabled.



## Assigning A System And/Or Setup Password

 **NOTE:** The password jumper enables or disables the System Password and Setup Password features. For more information on the password jumper settings, see System Board Jumper Settings.

You can assign a new **System Password** and/or **Setup Password** or change an existing **System Password** and/or **Setup Password** only when the password jumper setting is enabled and **Password Status** is **Unlocked**. If the Password Status is **Locked**, you cannot change the System Password.

If the password jumper setting is disabled, the existing System Password and Setup Password is deleted and you need not provide the system password to log on to the system.

To assign a system and/or setup password:

1. To enter System Setup, press <F2> immediately after a power-on or reboot.
2. In the **System Setup Main Menu**, select **System BIOS** and press <Enter>. The **System BIOS** screen is displayed.
3. In the **System BIOS** screen, select **System Security** and press <Enter>. The **System Security** screen is displayed.
4. In the **System Security** screen, verify that **Password Status** is **Unlocked**.
5. Select **System Password**, enter your system password, and press <Enter> or <Tab>.

Use the following guidelines to assign the system password:

- A password can have up to 32 characters.
- The password can contain the numbers 0 through 9.
- Only lower case letters are valid, upper case letters are not allowed.
- Only the following special characters are allowed: space, ("), (+), (.), (-), (.), (/), (:), ([), (\), (]), (').

A message prompts you to re-enter the system password.

6. Re-enter the system password that you entered earlier and click **OK**.
7. Select **Setup Password**, enter your system password and press <Enter> or <Tab>. A message prompts you to re-enter the setup password.
8. Re-enter the setup password that you entered earlier and click **OK**.
9. Press <Esc> to return to the System BIOS screen. Press <Esc> again, and a message prompts you to save the changes.



 **NOTE:** Password protection does not take effect until the system reboots.

## Deleting Or Changing An Existing System And/Or Setup Password

Ensure that the Password jumper is set to enabled and the **Password Status** is **Unlocked** before attempting to delete or change the existing System and/or Setup password. You cannot delete or change an existing System password if the **Password Status** is **Locked**.

To delete or change the existing System and/or Setup password:

1. To enter System Setup, press <F2> immediately after a power-on or reboot.
2. In the **System Setup Main Menu**, select **System BIOS** and press <Enter>. The **System BIOS** screen is displayed.
3. In the **System BIOS Screen**, select **System Security** and press <Enter>. The **System Security** screen is displayed.

4. In the **System Security** screen, verify that **Password Status** is **Unlocked**.
5. Select **System Password**, alter or delete the existing system password and press <Enter> or <Tab>.
6. Select **Setup Password**, alter or delete the existing setup password and press <Enter> or <Tab>.  
 **NOTE:** If you change the System and/or Setup password a message prompts you to re-enter the new password. If you delete the System and/or Setup password, a message prompts you to confirm the deletion.
7. Press <Esc> to return to the System BIOS screen. Press <Esc> again, and a message prompts you to save the changes.  
 **NOTE:** You can disable password security while logging on to the system. To disable the password security, turn on or reboot your system, type your password and press <Ctrl><Enter>.

## Using Your System Password To Secure Your System

 **NOTE:** If you have assigned a setup password, the system accepts your setup password as an alternate system password.

1. Turn on or reboot your system.
2. Type your password and press <Enter>.

When **Password Status** is **Locked**, type the password and press <Enter> when prompted at reboot.

If an incorrect system password is entered, the system displays a message and prompts you to re-enter your password. You have three attempts to enter the correct password. After the third unsuccessful attempt, the system displays an error message that the system has halted and must be powered down.

Even after you shut down and restart the system, the error message is displayed until the correct password is entered.

 **NOTE:** You can use the **Password Status** option in conjunction with the **System Password** and **Setup Password** options to protect your system from unauthorized changes.

## Operating With A Setup Password Enabled

If **Setup Password** is **Enabled**, enter the correct setup password before modifying most of the System Setup options.

If you do not enter the correct password in three attempts, the system displays the message

```
Invalid Password! Number of unsuccessful password attempts: <x> System Halted!  
Must power down.
```

Even after you shut down and restart the system, the error message is displayed until the correct password is entered. The following options are exceptions:

- If **System Password** is not **Enabled** and is not locked through the **Password Status** option, you can assign a system password.
- You cannot disable or change an existing system password.

 **NOTE:** You can use the Password Status option in conjunction with the **Setup Password** option to protect the system password from unauthorized changes.

## Entering The UEFI Boot Manager

 **NOTE:** Operating systems must be 64-bit UEFI-compatible (for example, Microsoft Windows Server 2008 x64 version) to be installed from the UEFI boot mode. DOS and 32-bit operating systems can only be installed from the BIOS boot mode.

The Boot Manager enables you to:

- Add, delete, and arrange boot options.
- Access System Setup and BIOS-level boot options without restarting.

To enter the Boot Manager:

1. Turn on or restart your system.
2. Press **<F11>** after you see the following message:

`<F11> = UEFI Boot Manager`

If your operating system begins to load before you press **<F11>**, allow the system to finish booting, and then restart your system and try again.

## Using The Boot Manager Navigation Keys

Key	Description
Up arrow	Moves to the previous field.
Down arrow	Moves to the next field.
<Enter>	Allows you to type in a value in the selected field (if applicable) or follow the link in the field.
Spacebar	Expands or collapses a drop-down list, if applicable.
<Tab>	Moves to the next focus area.
	 <b>NOTE:</b> For the standard graphics browser only.
<Esc>	Moves to the previous page till you view the main screen. Pressing <Esc> in the main screen exits the Boot Manager and proceeds with system boot.
<F1>	Displays the System Setup help file.

 **NOTE:** For most of the options, any changes that you make are recorded but do not take effect until you restart the system.

## Boot Manager Screen

Menu Item	Description
<b>Continue Normal Boot</b>	The system attempts to boot to devices starting with the first item in the boot order. If the boot attempt fails, the system continues with the next item in the boot order until the boot is successful or no more boot options are found.
<b>BIOS Boot Menu</b>	Displays the list of available BIOS boot options (marked with asterisks). Select the boot option you wish to use and press <Enter>.
<b>UEFI Boot Menu</b>	Displays the list of available UEFI boot options (marked with asterisks). Select the boot option you wish to use and press <Enter>. The UEFI Boot Menu enables you to <b>Add Boot Option</b> , <b>Delete Boot Option</b> , or <b>Boot From File</b> .
<b>Driver Health Menu</b>	Displays a list of the drivers installed on the system and their health status.
<b>Launch System Setup</b>	Enables you to access the System Setup.
<b>System Utilities</b>	Enables you to access the BIOS Update File Explorer, run the Dell Diagnostics program, and reboot the system.

## UEFI Boot Menu

Menu Item	Description
<b>Select UEFI Boot Option</b>	Displays the list of available UEFI boot options (marked with asterisks), select the boot option you wish to use and press <Enter>.
<b>Add Boot Option</b>	Adds a new boot option.
<b>Delete Boot Option</b>	Deletes an existing boot option.
<b>Boot From File</b>	Sets a one-time boot option not included in the boot option list.

## Embedded System Management

The Dell Lifecycle Controller provides advanced embedded systems management throughout the server's lifecycle. The Lifecycle Controller can be started during the boot sequence and can function independently of the operating system.

 **NOTE:** Certain platform configurations may not support the full set of features provided by the Lifecycle Controller.

For more information about setting up the Lifecycle Controller, configuring hardware and firmware, and deploying the operating system, see the Lifecycle Controller documentation at [dell.com/support/manuals](http://dell.com/support/manuals).

## iDRAC Settings Utility

The iDRAC Settings utility is an interface to setup and configure the iDRAC parameters using UEFI. You can enable or disable various iDRAC parameters using the iDRAC Settings Utility.

 **NOTE:** Accessing some of the features on the iDRAC Settings Utility requires the iDRAC7 Enterprise License upgrade.

For more information on using iDRAC, see the *iDRAC7 User's Guide* under **Software** → **Systems Management** → **Dell Remote Access Controllers**, at [dell.com/support/manuals](http://dell.com/support/manuals).

### Entering The iDRAC Settings Utility

1. Turn on or restart the managed system.
2. Press <F2> during Power-on Self-test (POST).
3. In the **System Setup Main Menu** page, click **iDRAC Settings**.  
The iDRAC Settings screen is displayed.

### Changing The Thermal Settings

The iDRAC Settings utility enables you to select and customize the thermal control settings for your system.

1. Enter the iDRAC Settings utility.
2. Under **iDRAC Settings** → **Thermal** → **User Option**, select between the following options:
  - Default
  - Maximum Exhaust Temperature
  - Fan Speed Offset

 **NOTE:** When the **User Option** is set to the default **Auto** setting, the user option cannot be modified.

3. Set the **Maximum Air Exhaust Temperature** or the **Fan Speed Offset** fields.
4. Click **Back** → **Finish** → **Yes**.



# Installing System Components

## Recommended Tools

You may need the following items to perform the procedures in this section:

- Key to the system keylock
- #1 and #2 Phillips screwdrivers
- T10 and T15 Torx screwdrivers
- Wrist grounding strap connected to ground

Following tools are required for assembling cables for a DC power supply unit (PSU), when available:

- Wire-stripper pliers capable of removing insulation from size 10 AWG solid or stranded, insulated copper wire
- AMP 90871-1 hand-crimping tool or equivalent

 **NOTE:** Use alpha wire part number 3080 or equivalent (65/30 stranding).

## Front Bezel (Optional)

### Installing The Front Bezel

1. Hook the right end of the bezel onto the chassis.
2. Fit the free end of the bezel onto the system.
3. Secure the bezel with the keylock.

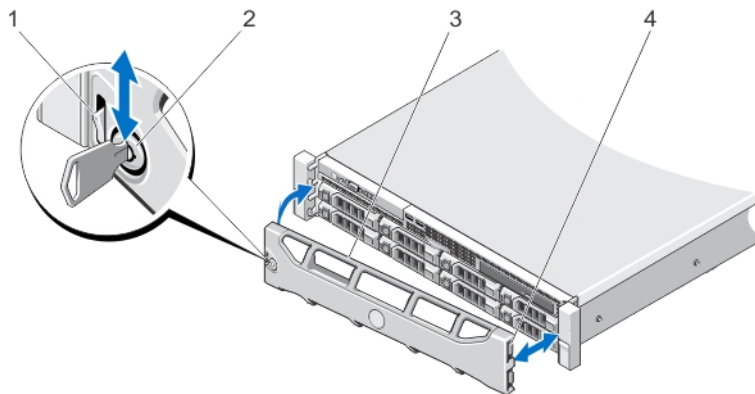

**Figure 11. Installing and Removing the Front Bezel**

1. release latch

2. keylock
3. front bezel
4. locking hook

## Removing The Front Bezel

1. Unlock the keylock at the left end of the bezel.
2. Lift the release latch next to the keylock.
3. Rotate the left end of the bezel away from the front panel.
4. Unhook the right end of the bezel and pull the bezel away from the system.

## Opening And Closing The System

 **WARNING:** Whenever you need to lift the system, get others to assist you. To avoid injury, do not attempt to lift the system by yourself.

 **WARNING:** Opening or removing the system cover when the system is on may expose you to a risk of electric shock.

 **CAUTION:** Many repairs may only be done by a certified service technician. You should only perform troubleshooting and simple repairs as authorized in your product documentation, or as directed by the online or telephone service and support team. Damage due to servicing that is not authorized by Dell is not covered by your warranty. Read and follow the safety instructions that came with the product.

 **CAUTION:** Do not operate the system without the cover for a duration exceeding five minutes.

## Opening The System

 **NOTE:** It is recommended that you always use a static mat and static strap while working on components in the interior of the system.

1. Turn off the system and attached peripherals, and disconnect the system from the electrical outlet.
2. Rotate the latch release lock counter clockwise to the unlocked position.
3. Lift the latch on top of the system and slide the cover back.
4. Grasp the cover on both sides and carefully lift the cover away from the system.



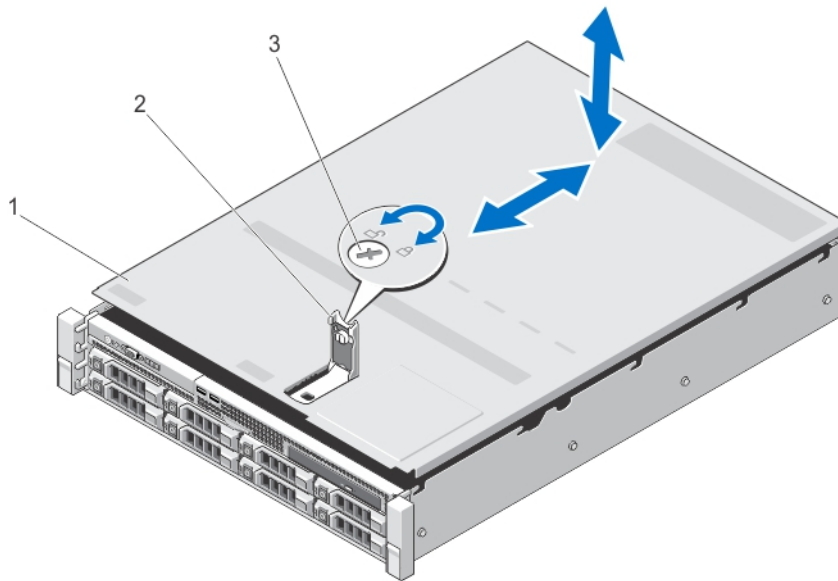

**Figure 12. Opening and Closing the System**

1. system cover
2. latch
3. latch release lock

## Closing The System

1. Lift the latch on the cover.
2. Place the cover onto the chassis and offset the cover slightly back so that it clears the chassis hooks and lays flush on the chassis.
3. Push down the latch to move the cover into the closed position.
4. Rotate the latch release lock in a clockwise direction to secure the cover.
5. Reconnect the system to its electrical outlet and turn the system on, including any attached peripherals.

## Inside The System

**⚠ CAUTION:** Many repairs may only be done by a certified service technician. You should only perform troubleshooting and simple repairs as authorized in your product documentation, or as directed by the online or telephone service and support team. Damage due to servicing that is not authorized by Dell is not covered by your warranty. Read and follow the safety instructions that came with the product.

**🔧 NOTE:** Components that are hot-swappable are marked orange, and touch-points on the components are marked blue.

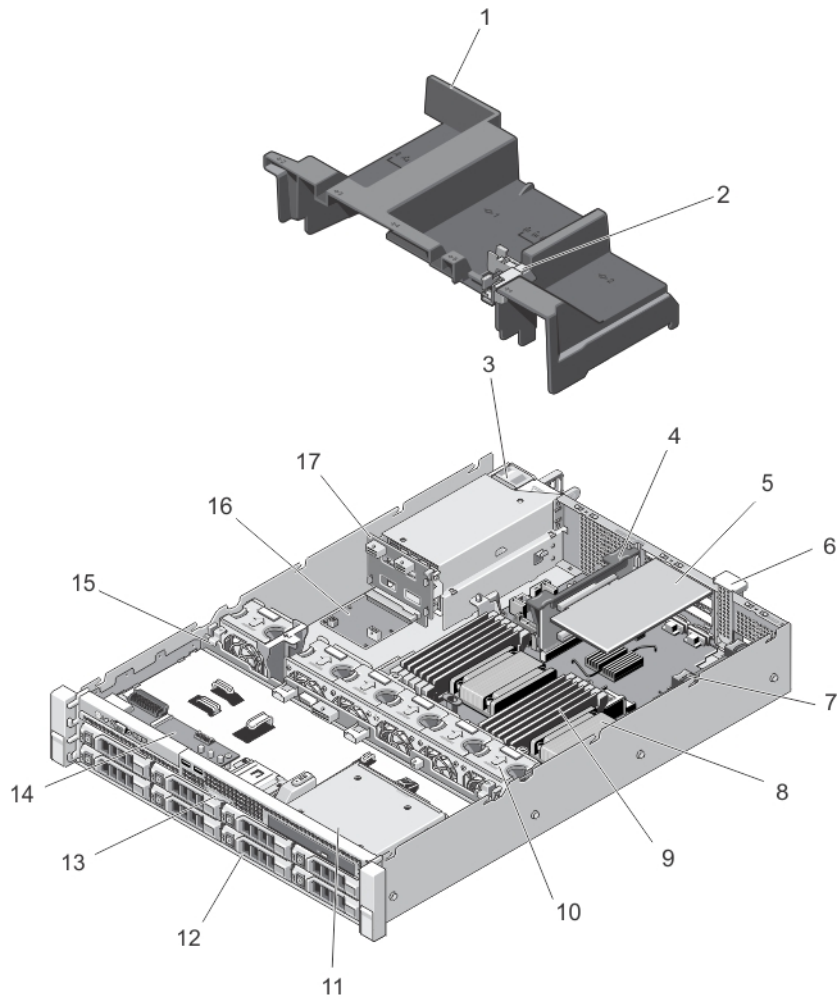

**Figure 13. Inside the System—Redundant Power Supply Unit Chassis**

- |    |                           |     |                          |
|----|---------------------------|-----|--------------------------|
| 1. | cooling shroud            | 10. | cooling fans (6)         |
| 2. | expansion-card latch      | 11. | optical drive (optional) |
| 3. | power supply (redundant)  | 12. | hard drives (8)          |
| 4. | expansion-card riser 2    | 13. | information tag          |
| 5. | expansion card            | 14. | control-panel board      |
| 6. | expansion-card latch      | 15. | hard-drive backplane     |
| 7. | expansion-card riser 1    | 16. | power-distribution board |
| 8. | heat sink for processor 1 | 17. | power-interposer board   |
| 9. | DIMMs (12)                |     |                          |

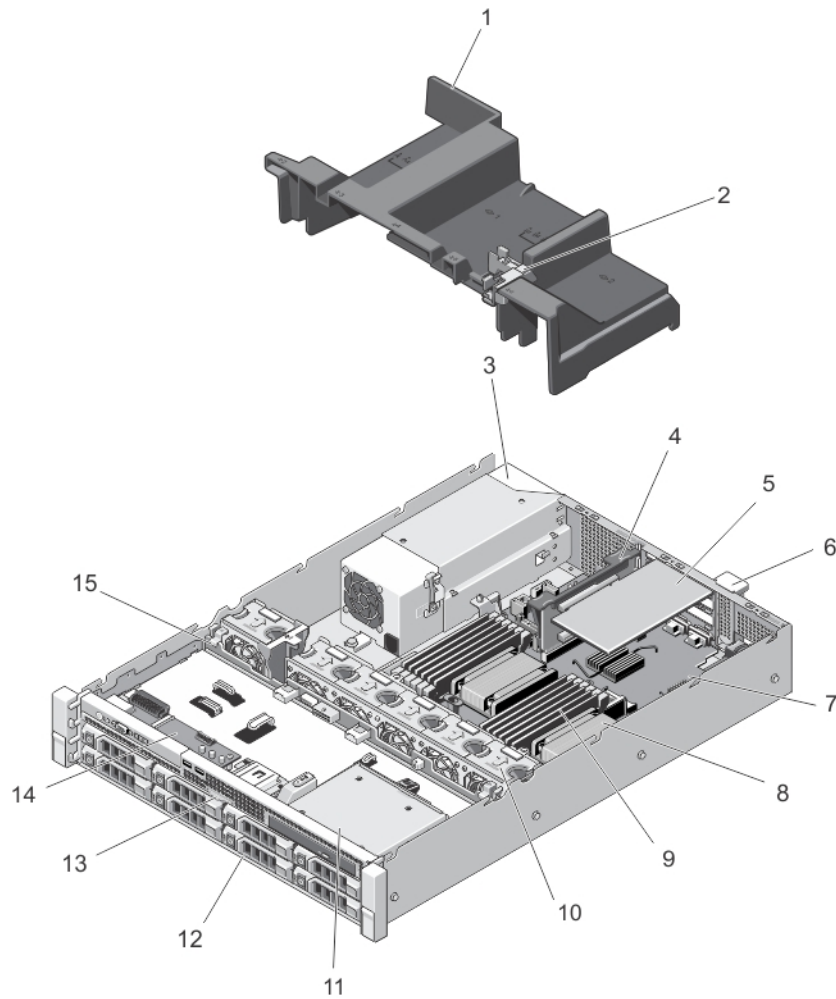

**Figure 14. Inside the System—Non-Redundant Power Supply Unit Chassis**

- |    |                              |     |                          |
|----|------------------------------|-----|--------------------------|
| 1. | cooling shroud               | 9.  | DIMMs (12)               |
| 2. | expansion-card latch         | 10. | cooling fans (6)         |
| 3. | power supply (non-redundant) | 11. | optical drive (optional) |
| 4. | expansion-card riser 2       | 12. | hard drives (8)          |
| 5. | expansion card               | 13. | information tag          |
| 6. | expansion-card latch         | 14. | control-panel board      |
| 7. | expansion-card riser 1       | 15. | hard-drive backplane     |
| 8. | heat sink for processor 1    |     |                          |

## Cooling Shroud

## Removing The Cooling Shroud

**△ CAUTION:** Many repairs may only be done by a certified service technician. You should only perform troubleshooting and simple repairs as authorized in your product documentation, or as directed by the online or telephone service and support team. Damage due to servicing that is not authorized by Dell is not covered by your warranty. Read and follow the safety instructions that came with the product.

**△ CAUTION:** Never operate your system with the cooling shroud removed. The system may get overheated quickly, resulting in shutdown of the system and loss of data.

1. Turn off the system, including any attached peripherals, and disconnect the system from the electrical outlet and peripherals.
2. Open the system.
3. If applicable, remove the full-length full-height expansion card installed on slot 2 of the expansion-card riser 2
4. Hold the touch points and lift the cooling shroud away from the system.

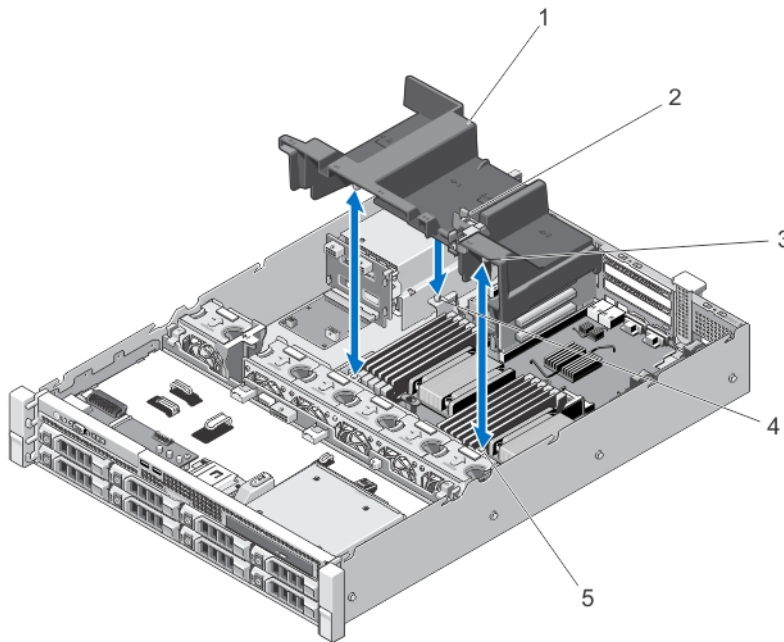

**Figure 15. Removing and Installing the Cooling Shroud**

- |   |  |
|---|--|
| 1. cooling shroud   | 5. cooling shroud alignment slots on the fan bracket (2) |
| 2. expansion-card latch   |  |
| 3. tabs (3)   |  |
| 4. cooling shroud alignment slot on the cable retention bracket |  |

## Installing The Cooling Shroud

 **CAUTION:** Many repairs may only be done by a certified service technician. You should only perform troubleshooting and simple repairs as authorized in your product documentation, or as directed by the online or telephone service and support team. Damage due to servicing that is not authorized by Dell is not covered by your warranty. Read and follow the safety instructions that came with the product.

 **NOTE:** For proper seating of the cooling shroud in the system chassis, ensure that the cables inside the system are routed appropriately.

1. Align the tabs on the cooling shroud with the alignment slots on the fan bracket, and the cable retention bracket.
2. Lower the cooling shroud into the chassis until firmly seated.
3. If applicable, install the full-length full-height expansion card on slot 2 of expansion-card riser 2.
4. Close the system.
5. Reconnect the system to its electrical outlet and turn the system on, including any attached peripherals.

## System Memory

Your system supports DDR3 unbuffered ECC DIMMs (UDIMM ECC) and registered DIMMs (RDIMMs). It supports DDR3 and DDR3L voltage specifications.

 **NOTE:** MT/s indicates DIMM speed in MegaTransfers per second.

Memory bus operating frequency can be 1600 MT/s, 1333 MT/s, 1066 MT/s, or 800 MT/s depending on:

- DIMM type (UDIMM or RDIMM)
- DIMM configuration (number of ranks)
- maximum frequency of the DIMMs
- number of DIMMs populated per channel
- DIMM operating voltage
- system profile selected (for example, Performance Optimized, Custom, or Dense Configuration Optimized)
- maximum supported DIMM frequency of the processors

The following table shows the memory populations and operating frequencies for the supported configurations.

DIMM Type	DIMMs Populated/ Channel	Operating Frequency (in MT/s)		Maximum DIMM Rank/ Channel
		1.5 V	1.35 V	
UDIMM ECC	1	1333, 1066, and 800	1333, 1066 and 800	Dual rank
	2	1333, 1066, and 800	1066 and 800	Dual rank
RDIMM	1	1600, 1333, 1066 and 800	1333, 1066 and 800	Dual rank
		1333	1066 and 800	Quad rank
	2	1333, 1066 and 800	1066 and 800	Dual rank
		1600, 1333, 1066 and 1066 1066 and 800	1333, 1066, and 800 1066 and 800	Quad rank

The system contains 12 memory sockets split into two sets of six sockets, one set per processor. Each six-socket set is organized into three channels. In each channel, the release levers of the first socket is marked white and the second black.

 **NOTE:** DIMMs in sockets A1 to A6 are assigned to processor 1 and DIMMs in sockets B1 to B6 are assigned to processor 2.

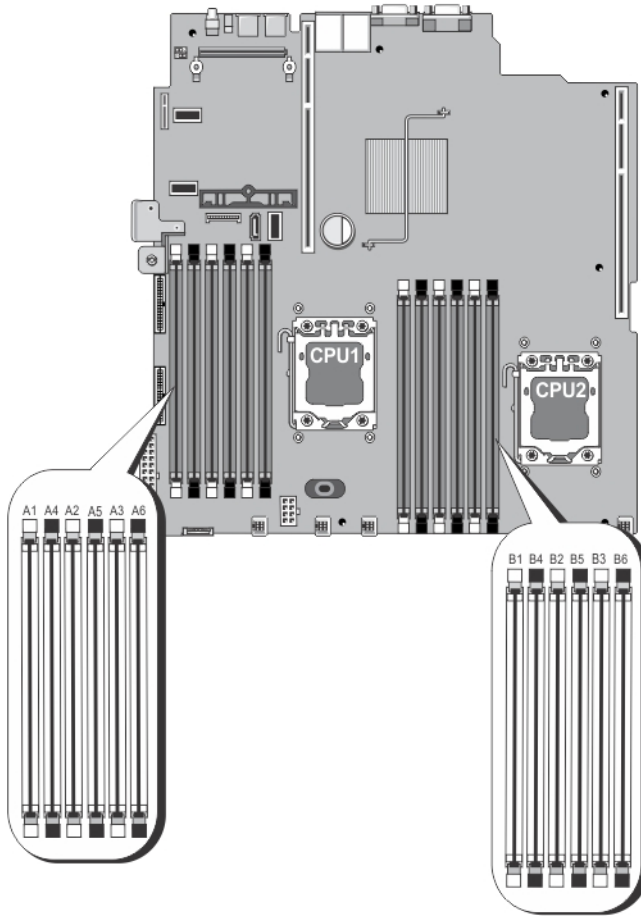

**Figure 16. Memory Socket Locations**

Memory channels are organized as follows:

- |                    |                                     |
|--------------------|-------------------------------------|
| <b>Processor 1</b> | channel 1: memory sockets A1 and A4 |
|                    | channel 2: memory sockets A2 and A5 |
|                    | channel 3: memory sockets A3 and A6 |
| <b>Processor 2</b> | channel 1: memory sockets B1 and B4 |
|                    | channel 2: memory sockets B2 and B5 |
|                    | channel 3: memory sockets B3 and B6 |

## General Memory Module Guidelines

This system supports Flexible Memory Configuration, enabling the system to be configured and run in any valid chipset architectural configuration. The following are the recommended guidelines for best performance:

- UDIMMs and RDIMMs must not be mixed.
- x4 and x8 DRAM based DIMMs can be mixed. For more information, see Mode-Specific Guidelines.
- A maximum of two UDIMMs can be populated in a channel.
- A maximum of two quad-rank RDIMMs can be populated in a channel.
- A maximum of two single- or dual-rank RDIMMs can be populated in a channel.
- One quad-rank RDIMM and one single- or dual-rank RDIMM can be populated per channel.
- Populate DIMM sockets only if a processor is installed. For single-processor systems, sockets A1 to A6 are available. For dual-processor systems, sockets A1 to A6 and sockets B1 to B6 are available.
- If a processor is installed, install DIMM blanks in the vacant memory sockets assigned to the processor to ensure proper system cooling.
- Populate all sockets with white release tabs first and then black.
- Populate the sockets by highest rank count in the following order - first in sockets with white release levers and then black. For example, if you want to mix quad-rank and dual-rank DIMMs, populate quad-rank DIMMs in the sockets with white release tabs and dual-rank DIMMs in the sockets with black release tabs.
- In a dual-processor configuration, the memory configuration for each processor must be identical. For example, if you populate socket A1 for processor 1, then populate socket B1 for processor 2, and so on.
- Memory modules of different sizes can be mixed provided that other memory population rules are followed (for example, 2 GB and 4 GB memory modules can be mixed).
- Depending on mode-specific guidelines, populate two or three DIMMs per processor (one DIMM per channel) at a time to maximize performance. For more information, see Mode-Specific Guidelines.
- If memory modules with different speeds are installed, they will operate at the speed of the slowest installed memory module(s) or slower depending on system DIMM configuration.

## Mode-Specific Guidelines

Three memory channels are allocated to each processor. The allowable configurations depend on the memory mode selected.

 **NOTE:** x4 and x8 DRAM based DIMMs can be mixed providing support for (Reliability, Availability, and Serviceability) RAS features. However, all guidelines for specific RAS features must be followed. x4 DRAM based DIMMs retain Single Device Data Correction (SDDC) in either memory optimized (independent channel) or Advanced ECC modes. x8 DRAM based DIMMs require Advanced ECC mode to gain SDDC.

The following sections provide additional slot population guidelines for each mode.

### Advanced ECC (Lockstep)

Advanced ECC mode extends SDDC from x4 DRAM based DIMMs to both x4 and x8 DRAMs. This protects against single DRAM chip failures during normal operation.

Memory installation guidelines:

- Memory sockets A1, A4, B1, and B4 are disabled and do not supported Advanced ECC mode.
- DIMMs must be installed in matched pairs — DIMMs installed in memory sockets (A2, B2) must match DIMMs installed in memory sockets (A3, B3) and DIMMs installed in memory sockets (A5, B5) must match DIMMs installed in memory sockets (A6, B6).

 **NOTE:** Advanced ECC with mirroring is not supported.

## Memory Optimized (Independent Channel) Mode

This mode supports SDDC only for memory modules that use x4 device width and does not impose any specific slot population requirements.

## Memory Sparing

 **NOTE:** To use memory sparing, this feature must be enabled in the System Setup.

In this mode, one rank per channel is reserved as a spare. If persistent correctable errors are detected on a rank, the data from this rank is copied to the spare rank and the failed rank is disabled.

With memory sparing enabled, the system memory available to the operating system is reduced by one rank per channel. For example, in a system with three 8 GB dual-rank DIMMs, the available system memory is: 1/2 (ranks/channel) × 3 (DIMMs) × 8 GB = 12 GB, and not 3 (DIMMs) × 8 GB = 24 GB.

 **NOTE:** Memory sparing does not offer protection against a multi-bit uncorrectable error.

 **NOTE:** Both Advanced ECC/Lockstep and Optimizer modes support Memory Sparing.

## Memory Mirroring

Memory Mirroring offers the strongest DIMM reliability mode compared to all other modes, providing improved uncorrectable multi-bit failure protection. In a mirrored configuration, the total available system memory is one half of the total installed physical memory. Half of the installed memory is used to mirror the active DIMMs. In the event of an uncorrectable error, the system will switch over to the mirrored copy. This ensures SDDC and multi-bit protection.

Memory installation guidelines:

 **NOTE:** The first memory channel for each processor (Channel 1) is disabled and not available for Memory Mirroring.

- Memory channels 2 and 3 must be populated.
- Memory modules must be identical in size, speed, and technology.
- DIMMs installed in memory sockets with white release tabs must be identical and similar rule applies for sockets with black release tabs. For example, DIMMs installed in sockets A2 and A3 must be identical.

## Sample Memory Configurations

The following tables show sample memory configurations that follow the appropriate memory guidelines stated in this section.

 **NOTE:** 16 GB quad-rank RDIMMs are not supported.

 **NOTE:** 1R, 2R, and 4R in the following tables indicate single-, dual-, and quad-rank DIMMs respectively.

**Table 1. Memory Configurations — Single Processor**

System Capacity (in GB)	DIMM Size (in GB)	Number of DIMMs	Organization and Speed	DIMM Slot Population
2	2	1	1R x8, 1333 MT/s 1R x8, 1600 MT/s	A1
4	2	2	1R x8, 1333 MT/s	A1, A2



System Capacity (in GB)	DIMM Size (in GB)	Number of DIMMs	Organization and Speed	DIMM Slot Population
10	2	5	1R x8, 1600 MT/s 1R x8, 1333 MT/s	A1, A2, A3, A4, A5
12	4	3	1R x8, 1600 MT/s 1R x8, 1333 MT/s	A1, A2, A3
20	4	5	1R x8, 1333 MT/s 1R x8, 1600 MT/s	A1, A2, A3, A4, A5
24	8	3	2R x4, 1333 MT/s 2R x4, 1600 MT/s	A1, A2, A3
32	8	4	2R x4, 1333 MT/s 2R x4, 1600 MT/s	A1, A2, A3, A4
48	16	3	2R x4, 1333 MT/s 2R x4, 1600 MT/s	A1, A2, A3
96	16	6	2R x4, 1333 MT/s 2R x4, 1600 MT/s	A1, A2, A3, A4, A5, A6
128	32	4	4R x4, 1066 MT/s	A1, A2, A3, A4
192	32	6	4R x4, 1066 MT/s	A1, A2, A3, A4, A5, A6

**Table 2. Memory Configurations — Two Processors**

System Capacity (in GB)	DIMM Size (in GB)	Number of DIMMs	Organization and Speed	DIMM Slot Population
4	2	2	1R x8, 1333 MT/s 1R x8, 1600 MT/s	A1, B1
8	2	4	1R x8, 1333 MT/s 1R x8, 1600 MT/s	A1, A2, B1, B2
12	2	6	1R x8, 1333 MT/s 1R x8, 1600 MT/s	A1, A2, A3, B1, B2, B3
24	4	6	2R x8, 1333 MT/s 2R x8, 1600 MT/s	A1, A2, A3, B1, B2, B3
48	8	6	2R x4, 1333 MT/s 2R x4, 1600 MT/s	A1, A2, A3, B1, B2, B3
96	16	6	2R x4, 1333 MT/s 2R x4, 1600 MT/s	A1, A2, A3, B1, B2, B3
128	16	8	2R x4, 1333 MT/s 2R x4, 1600 MT/s	A1, A2, A3, A4, B1, B2, B3, B4
160	16	10	2R x4, 1333 MT/s 2R x4, 1600 MT/s	A1, A2, A3, A4, A5, B1, B2, B3, B4, B5
192	16	12	2R x4, 1333 MT/s 2R x4, 1600 MT/s	A1, A2, A3, A4, A5, A6, B1, B2, B3, B4, B5, B6

System Capacity (in GB)	DIMM Size (in GB)	Number of DIMMs	Organization and Speed	DIMM Slot Population
256	32	8	4R x4, 1066 MT/s	A1, A2, A3, A4, B1, B2, B3, B4
384	32	12	4R x4, 1066 MT/s	A1, A2, A3, A4, A5, A6, B1, B2, B3, B4, B5, B6

## Removing Memory Modules

- ⚠ WARNING:** The memory modules are hot to the touch for some time after the system has been powered down. Allow time for the memory modules to cool before handling them. Handle the memory modules by the card edges and avoid touching the components or metallic contacts on the memory module.
- ⚠ CAUTION:** Many repairs may only be done by a certified service technician. You should only perform troubleshooting and simple repairs as authorized in your product documentation, or as directed by the online or telephone service and support team. Damage due to servicing that is not authorized by Dell is not covered by your warranty. Read and follow the safety instructions that came with the product.
- ⚠ CAUTION:** To ensure proper system cooling, memory-module blanks must be installed in any memory socket that is not occupied. Remove memory-module blanks only if you intend to install memory modules in those sockets.

1. Turn off the system, including any attached peripherals, and disconnect the system from the electrical outlet and peripherals.
2. Open the system.
3. Remove the cooling shroud.
4. Locate the appropriate memory-module socket(s).
5. To release the memory-module blank from the socket, simultaneously press the ejectors on both ends of the memory module socket.

- ⚠ CAUTION:** Handle each memory module only on the card edges, making sure not to touch the middle of the memory module or metallic contacts. To avoid damaging the memory module, handle only one memory module at a time.

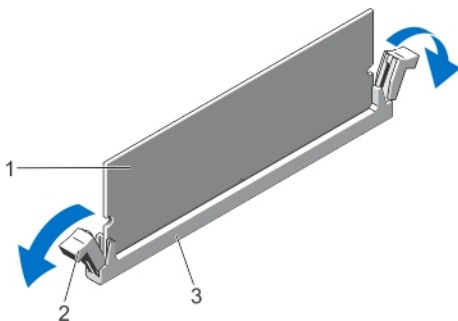

**Figure 17. Ejecting The Memory Module**

1. memory module
  2. memory-module socket ejectors (2)
  3. memory-module socket
6. If a memory module or a memory-module blank is installed in the socket, remove it.



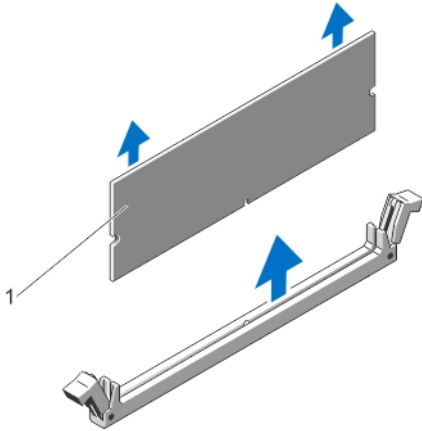



**🔑 NOTE:** Retain removed memory-module blank(s) for future use.



**Figure 18. Removing The Memory Module**

1. memory module/memory-module blank
7. Install the cooling shroud.
8. Close the system.
9. Reconnect the system to its electrical outlet and turn the system on, including any attached peripherals.

## Installing Memory Modules

-  **WARNING:** The memory modules are hot to the touch for some time after the system has been powered down. Allow time for the memory modules to cool before handling them. Handle the memory modules by the card edges and avoid touching the components or metallic contacts on the memory module.
  -  **CAUTION:** Many repairs may only be done by a certified service technician. You should only perform troubleshooting and simple repairs as authorized in your product documentation, or as directed by the online or telephone service and support team. Damage due to servicing that is not authorized by Dell is not covered by your warranty. Read and follow the safety instructions that came with the product.
  -  **CAUTION:** To ensure proper system cooling, memory-module blanks must be installed in any memory socket that is not occupied. Remove memory-module blanks only if you intend to install memory modules in those sockets.
1. Turn off the system, including any attached peripherals, and disconnect the system from the electrical outlet.
  2. Open the system.
  3. If applicable, remove the cooling shroud.
  4. Locate the memory-module sockets.
    -  **CAUTION:** Handle each memory module only by the card edges, making sure not to touch the middle of the memory module or metallic contacts. To avoid damaging the memory module, handle only one memory module at a time.
  5. If a memory module or a memory-module blank is installed in the socket, remove it.
    -  **NOTE:** Retain removed memory-module blank(s) for future use.
  6. Align the memory-module's edge connector with the alignment key of the memory-module socket, and insert the memory module in the socket.
    -  **NOTE:** The memory-module socket has an alignment key that allows you to install the memory module in the socket in only one orientation.

**⚠ CAUTION:** To prevent damage to the memory-module socket during installation, apply pressure at both ends of the memory module evenly. Do not apply pressure to the center of the memory module.

7. Press down on the memory module with your thumbs until the memory module snaps into place.

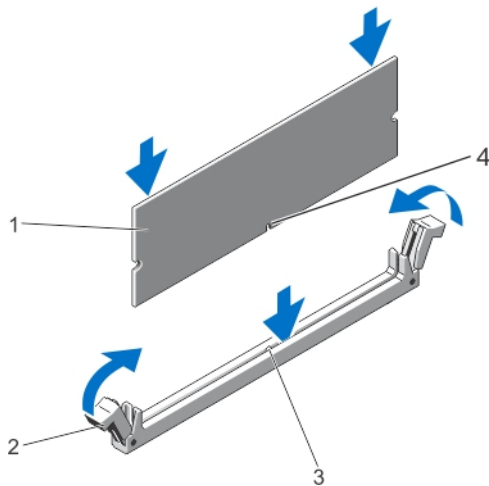

**Figure 19. Installing The Memory Module**

1. memory module
2. memory-module ejectors
3. memory-module socket alignment key
4. memory-module alignment key

**✎ NOTE:** When the memory module is properly seated in the socket, the levers on the memory-module socket align with the levers on the other identical sockets that have memory modules installed.

8. Repeat step 4 through step 7 of this procedure to install the remaining memory modules.
9. Replace the cooling shroud.
10. Close the system.
11. Reconnect the system to its electrical outlet and turn on the system, including any attached peripherals.
12. Press <F2> to enter the System Setup, and check the memory settings.  
The system should have already changed the value to reflect the newly installed memory.
13. If the value is incorrect, one or more of the memory modules may not be installed properly. Repeat step 4 through step 7 of this procedure, checking to ensure that the memory modules are firmly seated in their sockets.
14. Run the appropriate diagnostic test. For more information, see Using System Diagnostics.

## Hard Drives

Your system supports:

- up to eight 3.5 inch or 2.5 inch hot-swappable hard drives
- up to four 3.5 inch or 2.5 inch hot-swappable hard drives for software RAID

**✎ NOTE:** On software RAID systems, slots 4 through 7 are not functional and are pre-installed with dual slot hard-drive blanks.

All hard drives connect to the system board through the hard-drive backplane. Hot-swappable hard drives are supplied in hot-swappable hard-drive carriers that fit in the hard-drive slots.

**CAUTION:** Before attempting to remove or install a hard drive while the system is running, see the documentation for the storage controller card to ensure that the host adapter is configured correctly to support hot-swap hard drive removal and insertion.

**CAUTION:** Do not turn off or reboot your system while the hard drive is being formatted. Doing so can cause a hard drive failure.

**NOTE:** Use only hard drives that have been tested and approved for use with the hard-drive backplane.

When you format a hard drive, allow enough time for the formatting to be completed. Be aware that high-capacity hard drives can take a number of hours to format.

## Removing A 3.5 Inch Hard-Drive Blank

**CAUTION:** To maintain proper system cooling, all empty hard-drive slots must have drive blanks installed.

1. If installed, remove the front bezel.
2. Grasp the front of the hard-drive blank, press the release button and slide the blank out until it is free of the hard-drive slot.

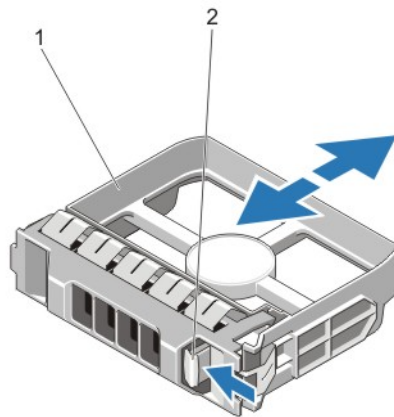

**Figure 20. Removing and Installing a 3.5 Inch Hard-Drive Blank**

1. hard-drive blank
2. release button

## Installing A 3.5 Inch Hard-Drive Blank

**CAUTION:** To avoid damaging the hard-drive blank's metal spring, follow the hard-drive blank installation sequence described in the figure below.

1. If installed, remove the front bezel.
2. Insert the hard-drive blank into the hard-drive slot until the release button clicks into place.
3. If applicable, install the front bezel.

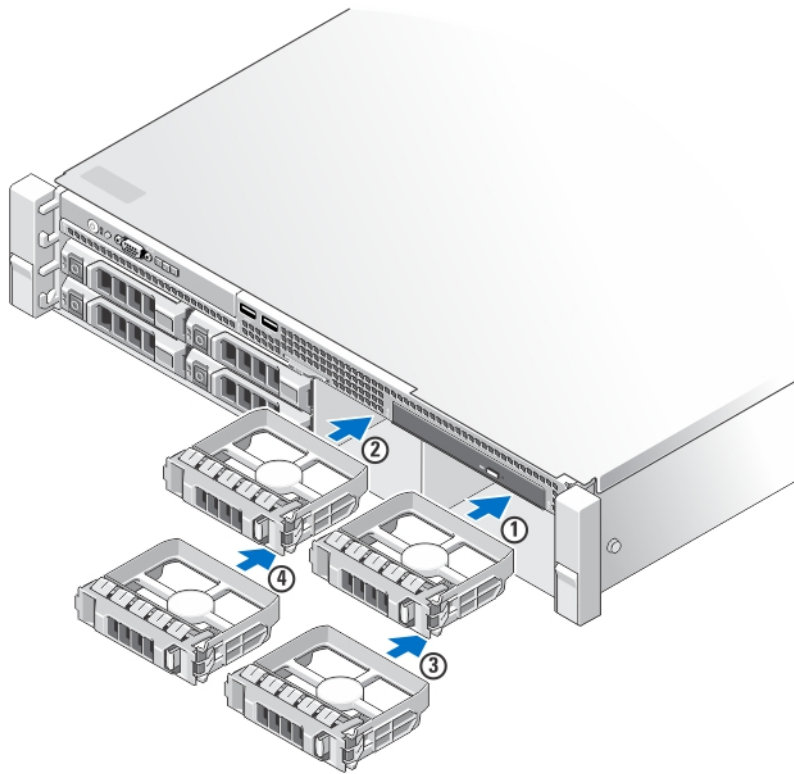

Figure 21. Hard-Drive Blank Installation Sequence

## Removing A Dual Slot Hard-Drive Blank

**CAUTION:** To maintain proper system cooling, all empty hard-drive slots must have hard-drive blanks installed.

**NOTE:** Systems configured for software RAID support only four hard drives. The remaining hard-drive slots are pre-installed with dual slot hard-drive blanks, and are not available for software RAID.

**NOTE:** This is a service only procedure.

1. If installed, remove the front bezel.
2. Using a screwdriver, push the release tabs to unlock the dual slot hard-drive blank from the chassis.
3. Pull the hard-drive blank at the corners until it is free of the hard-drive slot.

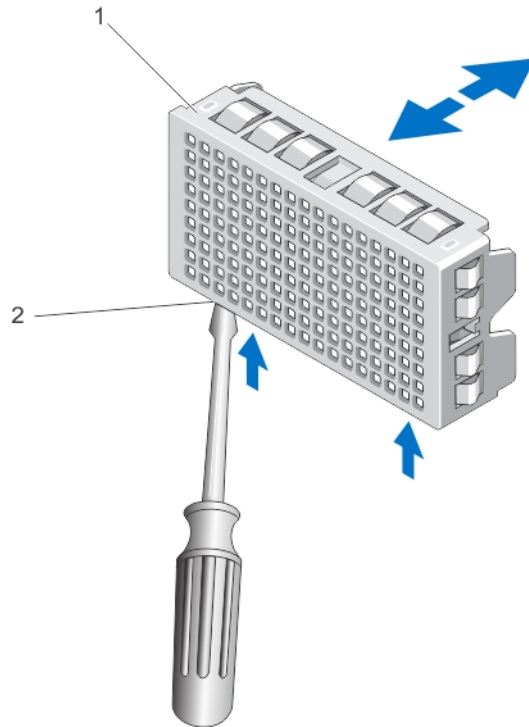

**Figure 22. Removing and Installing A Dual Slot Hard-Drive Blank**

1. dual slot hard-drive blank
2. release tabs (2)

### Installing A Dual Slot Hard-Drive Blank

1. If installed, remove the front bezel.
2. Insert the dual slot hard-drive blank into the hard-drive slot, and push it until the release tabs click into place.
3. If applicable, install the front bezel.

### Removing A Hot-Swap Hard Drive

**△ CAUTION: To prevent data loss, ensure that your operating system supports hot-swap drive installation. See the documentation supplied with your operating system.**

1. From the management software, prepare the hard drive for removal. Wait until the indicators on the hard-drive carrier signal that the hard drive can be removed safely. For more information, see the documentation for the storage controller.  
If the hard drive is online, the green activity/fault indicator flashes as the drive is turned off. When the hard-drive indicators are off, the hard drive is ready for removal.

2. Press the release button to open the hard-drive carrier release handle.
3. Slide the hard-drive carrier out until it is free of the hard-drive slot.

**△ CAUTION: To maintain proper system cooling, all empty hard-drive slots must have hard-drive blanks installed.**

4. Insert a hard-drive blank in the empty hard-drive slot.

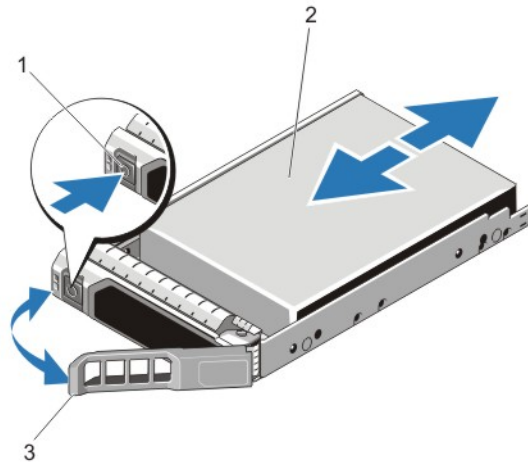

**Figure 23. Removing and Installing a Hot-Swap Hard Drive**

1. release button
2. hard drive
3. hard-drive carrier handle

## Installing A Hot-Swap Hard Drive

- △ **CAUTION:** Many repairs may only be done by a certified service technician. You should only perform troubleshooting and simple repairs as authorized in your product documentation, or as directed by the online or telephone service and support team. Damage due to servicing that is not authorized by Dell is not covered by your warranty. Read and follow the safety instructions that came with the product.
- △ **CAUTION:** Use only hard drives that have been tested and approved for use with the hard-drive backplane.
- △ **CAUTION:** Combining SAS and SATA hard drives in the same RAID volume is not supported.
- △ **CAUTION:** When installing a hard drive, ensure that the adjacent drives are fully installed. Inserting a hard-drive carrier and attempting to lock its handle next to a partially installed carrier can damage the partially installed carrier's shield spring and make it unusable.
- △ **CAUTION:** To prevent data loss, ensure that your operating system supports hot-swap drive installation. See the documentation supplied with your operating system.
- △ **CAUTION:** When a replacement hot-swappable hard drive is installed and the system is powered on, the hard drive automatically begins to rebuild. Make absolutely sure that the replacement hard drive is blank or contains data that you wish to have over-written. Any data on the replacement hard drive is immediately lost after the hard drive is installed.

1. If a hard-drive blank is installed in the hard-drive slot, remove it.
2. Install a hard drive in the hard-drive carrier.
3. Press the release button on the front of the hard-drive carrier and open the hard-drive carrier handle.
4. Insert the hard-drive carrier into the hard-drive slot until the carrier connects with the backplane.
5. Close the hard-drive carrier handle to lock the hard drive in place.



## Removing A 2.5 Inch Hard Drive From A 3.5 Inch Hard-Drive Adapter

 **NOTE:** A 2.5 inch hard drive is installed into a 3.5 inch hard-drive adapter, which is then installed in the 3.5 inch hard-drive carrier

1. Remove the two screws from the side of the 3.5 inch hard-drive adapter.
2. Remove the hard-drive away from the hard-drive adapter.

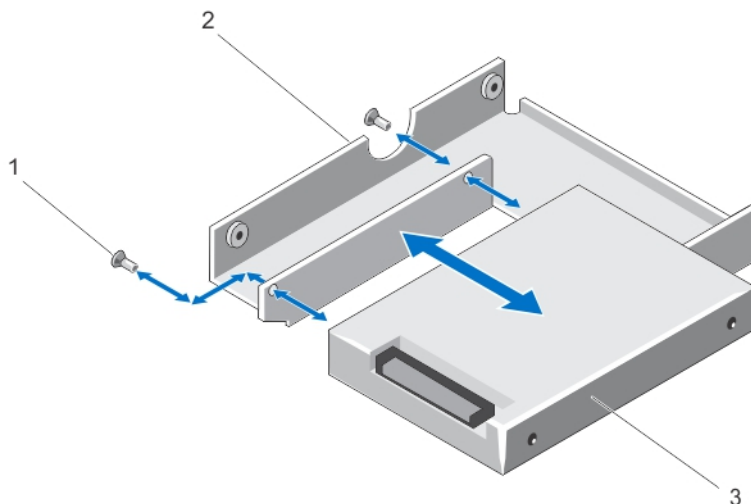



Figure 24. Removing and Installing a 2.5 Inch Hard Drive Into a 3.5 Inch Hard-Drive Adapter

1. screws (2)
2. 3.5 inch hard-drive adapter
3. 2.5 inch hard drive

## Installing A 2.5 Inch Hard Drive Into A 3.5 Inch Hard-Drive Adapter

 **CAUTION:** Many repairs may only be done by a certified service technician. You should only perform troubleshooting and simple repairs as authorized in your product documentation, or as directed by the online or telephone service and support team. Damage due to servicing that is not authorized by Dell is not covered by your warranty. Read and follow the safety instructions that came with the product.

1. Align the screw holes on the 2.5 inch hard drive with the screw holes on the 3.5 inch hard-drive adapter.
2. Install the screws to secure the hard drive to the hard-drive adapter.

## Removing A Hard Drive Or A Hard-Drive Adapter From A Hard-Drive Carrier

1. Remove the screws from the slide rails on the hard-drive carrier.
2. Lift the hard-drive adapter out of the hard-drive carrier.

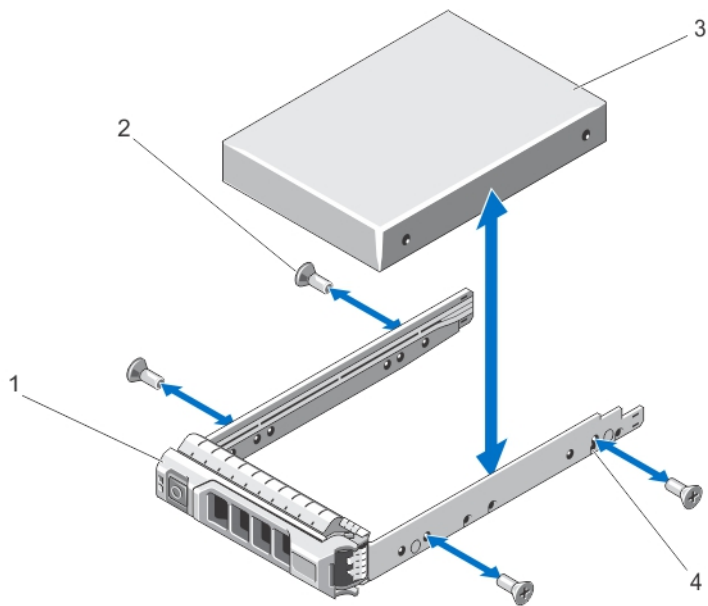

**Figure 25. Removing and Installing a Hot-Swap Hard Drive Into a Hard-Drive Carrier**

1. hard-drive carrier
2. screws (4)
3. hard drive
4. screw holes (4)

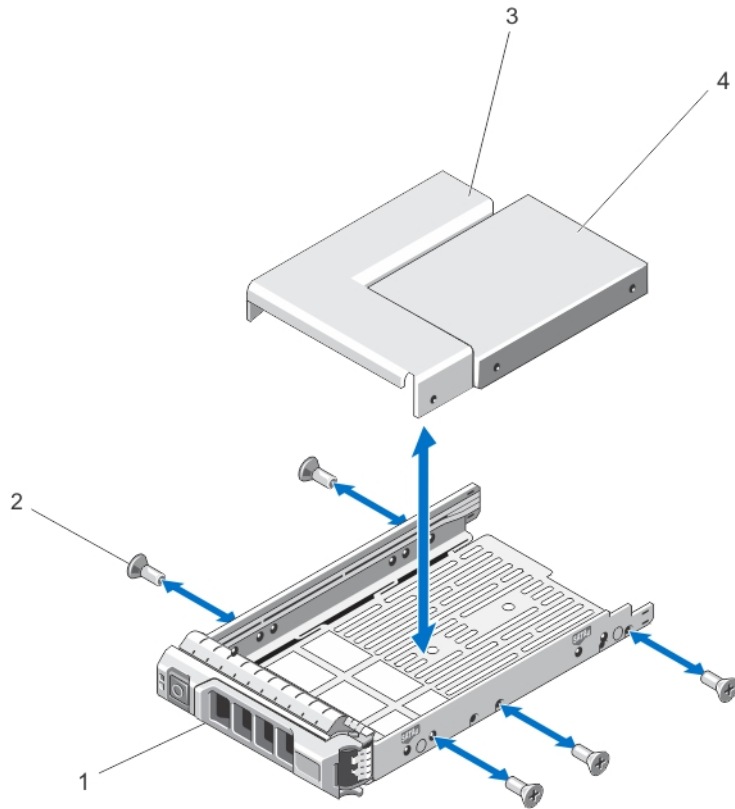

**Figure 26. Removing and Installing a Hard-Drive Adapter Into a 3.5 Inch Hard-Drive Carrier**

1. hard-drive carrier
2. screws (5)
3. hard-drive adapter
4. 2.5 inch hard drive

### Installing A Hard Drive Or A Hard-Drive Adapter Into A Hard-Drive Carrier

**⚠ CAUTION:** Many repairs may only be done by a certified service technician. You should only perform troubleshooting and simple repairs as authorized in your product documentation, or as directed by the online or telephone service and support team. Damage due to servicing that is not authorized by Dell is not covered by your warranty. Read and follow the safety instructions that came with the product.

1. Insert the hard-drive adapter into the hard-drive carrier with the connector end of the hard drive toward the back.
2. Align the screw holes on the hard drive with the back set of holes on the hard-drive carrier.  
When aligned correctly, the back of the hard drive is flush with the back of the hard-drive carrier.
3. Attach the screws to secure the hard drive to the hard-drive carrier.

# Optical Drive (Optional)

## Removing The Optical Drive

**△ CAUTION:** Many repairs may only be done by a certified service technician. You should only perform troubleshooting and simple repairs as authorized in your product documentation, or as directed by the online or telephone service and support team. Damage due to servicing that is not authorized by Dell is not covered by your warranty. Read and follow the safety instructions that came with the product.

1. If installed, remove the front bezel.
2. Turn off the system, including any attached peripherals, and disconnect the system from the electrical outlet and peripherals.
3. Open the system.
4. Disconnect the power/data cable from the back of the optical drive.  
Note the routing of the power/data cable on the side on the system as you remove them from the system board and drive. You must route these cables properly when you replace them to prevent them from being pinched or crimped.
5. To remove the optical drive, press down and push the blue release tab toward the front of the system.
6. Slide the optical drive out of the system until it is free of the drive bay.
7. If you are not adding a new optical drive, install the optical drive blank.
8. Close the system.
9. Reconnect the system to its electrical outlet and turn the system on, including any attached peripherals.
10. If applicable, install the front bezel.

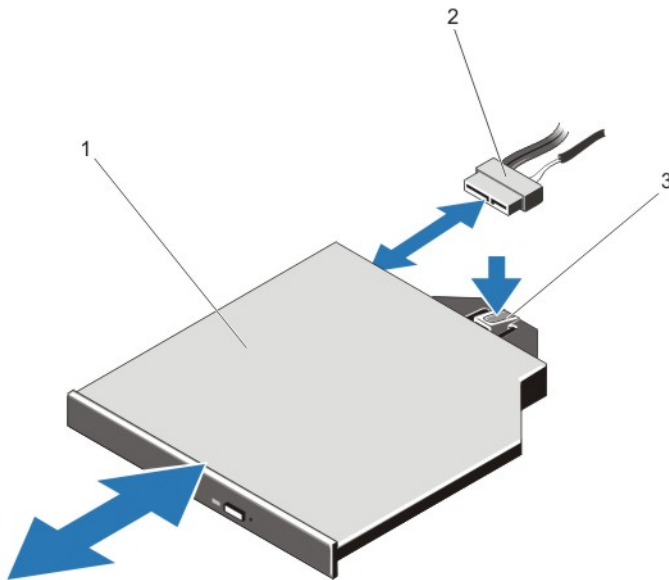

**Figure 27. Removing and Installing the Optical Drive**

1. optical drive
2. power and data cable
3. release tab

## Installing The Optical Drive

 **CAUTION:** Many repairs may only be done by a certified service technician. You should only perform troubleshooting and simple repairs as authorized in your product documentation, or as directed by the online or telephone service and support team. Damage due to servicing that is not authorized by Dell is not covered by your warranty. Read and follow the safety instructions that came with the product.

1. If installed, remove the front bezel.
2. Turn off the system, including any attached peripherals, and disconnect the system from its electrical outlet.
3. Open the system.
4. Align the optical drive with its opening in the front panel.
5. Slide in the optical drive until the latch snaps into place.
6. Connect the power/data cable to the optical drive and system board.

 **NOTE:** You must route the cable properly on the side of the system to prevent it from being pinched or crimped.

7. Close the system.
8. Reconnect the system to its electrical outlet and turn the system on, including any attached peripherals.
9. If applicable, install the front bezel.

## Cooling Fans

Your system supports up to six cooling fans. For a system with only one processor, a dummy fan is pre-installed on the sixth cooling fan slot (FAN6). You must remove the dummy fan and install a cooling fan in the FAN6 slot when you install a second processor.

 **NOTE:** In the event of a problem with a particular fan, the fan number is referenced by the system's management software, allowing you to easily identify and replace the proper fan by noting the fan numbers.

## Removing A Cooling Fan

 **WARNING:** Opening or removing the system cover when the system is on may expose you to a risk of electric shock. Exercise utmost care while removing or installing cooling fans.

 **CAUTION:** Many repairs may only be done by a certified service technician. You should only perform troubleshooting and simple repairs as authorized in your product documentation, or as directed by the online or telephone service and support team. Damage due to servicing that is not authorized by Dell is not covered by your warranty. Read and follow the safety instructions that came with the product.

 **NOTE:** The procedure for removing each individual fan module is the same.

1. Turn off the system, including any attached peripherals, and disconnect the system from the electrical outlet and peripherals.
2. Open the system.
3. Remove the fan cable connector from the system board by pressing the tab on the cable end connector, and lifting it away from the system board.
4. Free the cable from the cable holders on the fan bracket.
5. Press the release tab on the cooling fan and lift the fan away from the chassis.

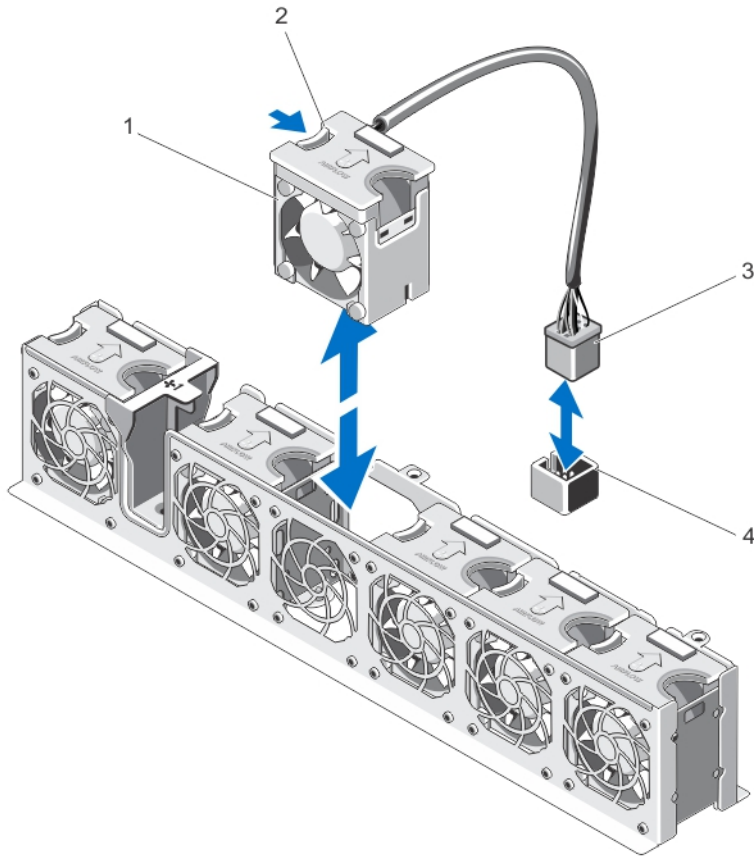

**Figure 28. Removing and Installing a Cooling Fan**

1. cooling fans (6)
2. cooling fan release tab
3. cooling fan cable connector
4. cooling fan connector on the system board

## Installing A Cooling Fan

**CAUTION:** Many repairs may only be done by a certified service technician. You should only perform troubleshooting and simple repairs as authorized in your product documentation, or as directed by the online or telephone service and support team. Damage due to servicing that is not authorized by Dell is not covered by your warranty. Read and follow the safety instructions that came with the product.

**NOTE:** If you install a second processor, you must:

- remove the dummy fan from the FAN6 slot
  - install a cooling fan in the FAN6 slot
  - upgrade both the expansion-card risers (riser 1 and riser 2)
1. Turn off the system, including any attached peripherals, and disconnect the system from the electrical outlet and peripherals.
  2. Open the system.

3. Remove the cooling shroud.
4. Align the fan with the cable end of the fan toward the system board.
5. Lower the fan into the fan bracket until it clicks into position.
6. Connect the fan's power cable to the power connector on the system board.
7. Route the cable through the cable holders on the fan bracket.
8. Replace the cooling shroud.
9. Close the system.
10. Reconnect the system to its electrical outlet and turn the system on, including any attached peripherals.

## Internal USB Memory Key (Optional)

An optional USB memory key installed inside your system can be used as a boot device, security key, or mass storage device. The USB connector must be enabled by the **Internal USB Port** option in the **Integrated Devices** screen of the **System Setup**.

To boot from the USB memory key, configure the USB memory key with a boot image, and then specify the USB memory key in the boot sequence in the **System Setup**.

 **NOTE:** The internal USB connector is located on the expansion-card riser 2.

### Replacing the Internal USB Key

 **CAUTION:** Many repairs may only be done by a certified service technician. You should only perform troubleshooting and simple repairs as authorized in your product documentation, or as directed by the online or telephone service and support team. Damage due to servicing that is not authorized by Dell is not covered by your warranty. Read and follow the safety instructions that came with the product.

1. Turn off the system, including any attached peripherals, and disconnect the system from the electrical outlet and peripherals.
2. Open the system.
3. Locate the USB connector / USB key on the expansion-card riser 2.
4. If installed, remove the USB key.
5. Insert the USB key into the USB connector.
6. Close the system.
7. Reconnect the system to its electrical outlet and turn the system on, including any attached peripherals.
8. Enter the System Setup and verify that the USB key is detected by the system.

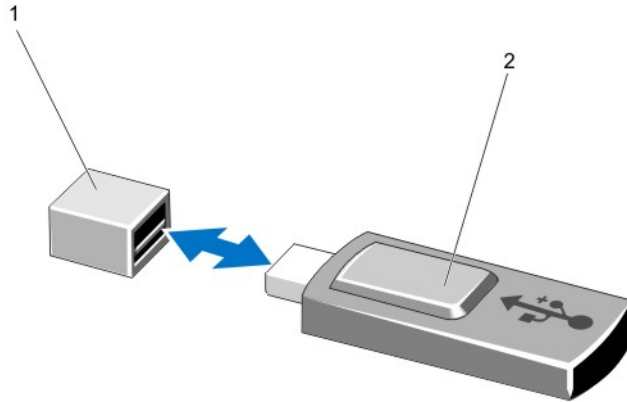

**Figure 29. Replacing the Internal USB Key**

1. USB memory key connector
2. USB memory key

## Expansion Cards And Expansion-Card Risers

**NOTE:** A missing or an unsupported expansion-card riser logs an SEL event. It does not prevent your system from powering on and no BIOS POST message or F1/F2 pause is displayed.

### Expansion-Card Installation Guidelines

Your system supports:

- PCI Express Generation 2 and Generation 3 expansion cards.
- Different expansion-card risers for single- and dual-processor configurations. The following table provides the riser configurations for single- and dual-processor systems:

**Table 3. Riser Configuration for Single- and Dual-Processor Systems**

Number of Processors	Expansion Card Slots	
	Riser 1	Riser 2
One	PCIE_G2_X4	PCIE_G3_X8
	iDRAC Ports Card	PCIE_G3_X4
		PCIE_G3_X4
Two	PCIE_G3_X16	PCIE_G3_X8
	iDRAC Ports Card	PCIE_G3_X8
		PCIE_G3_X8

**NOTE:** The expansion-card risers listed in the above table cannot be interchanged between single- and dual-processor systems.

- Only a three-fourth length GPU card is supported for the PCIe expansion card slot (slot 2) on riser 2.

Use the following table as a guide for installing expansion cards to ensure proper cooling and mechanical fit. The expansion cards with the highest priority must be installed first using the slot priority indicated. All other expansion cards must be installed in card priority and slot priority order.



**Table 4. Expansion-Card Installation Priority for Riser 2**

<b>Card Priority</b>	<b>Card Type</b>	<b>Slot Priority</b>	<b>Max Allowed</b>
1	External RAID	4, 3, 2	1
2	CNAs	4, 3, 2	3
3	10 Gb NICs	4, 3, 2	3
4	FC8 HBA	4, 3, 2	3
5	FC4 HBA	4, 3, 2	3
6	1 Gb NICs	4, 3, 2	3
7	Non-RAID	4, 3, 2	3
8	FC16 HBA	4, 3, 2	3

## Removing An Expansion Card

 **CAUTION:** Many repairs may only be done by a certified service technician. You should only perform troubleshooting and simple repairs as authorized in your product documentation, or as directed by the online or telephone service and support team. Damage due to servicing that is not authorized by Dell is not covered by your warranty. Read and follow the safety instructions that came with the product.

1. Turn off the system, including any attached peripherals, and disconnect the system from the electrical outlet and peripherals.
2. Open the system.
3. Lift the expansion-card latch.
4. Hold the expansion card by its edges and remove it from the expansion-card connector on the expansion-card riser.
5. If you are removing the card permanently, install a metal filler bracket over the empty expansion slot opening and close the expansion-card latch.

 **NOTE:** You must install a filler bracket over an empty expansion slot to maintain Federal Communications Commission (FCC) certification of the system. The brackets also keep dust and dirt out of the system and aid in proper cooling and airflow inside the system.

6. Close the system.
7. Reconnect the system to its electrical outlet and turn the system on, including any attached peripherals.

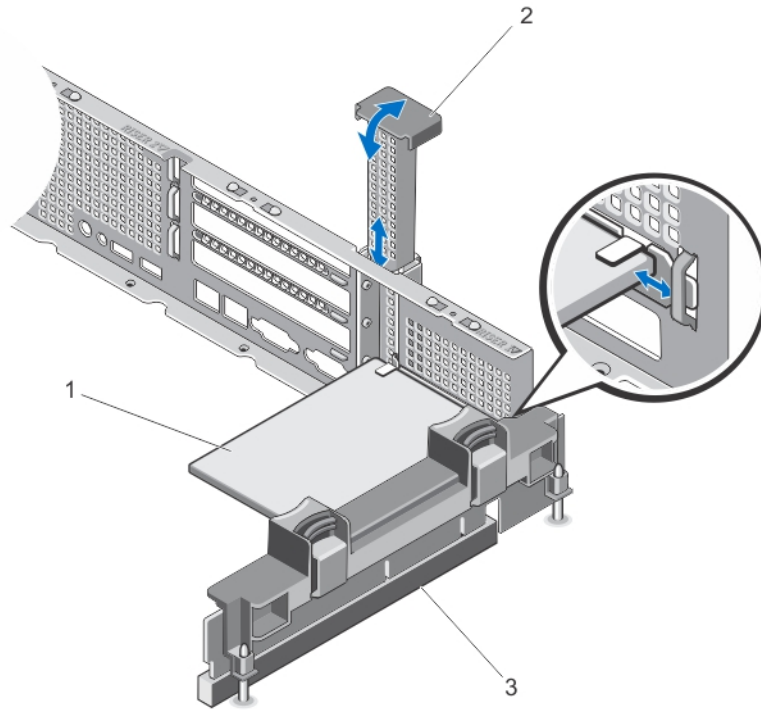

**Figure 30. Removing and Installing the Expansion Card from Expansion-Card Riser 1**

1. expansion card
2. expansion-card latch
3. riser 1

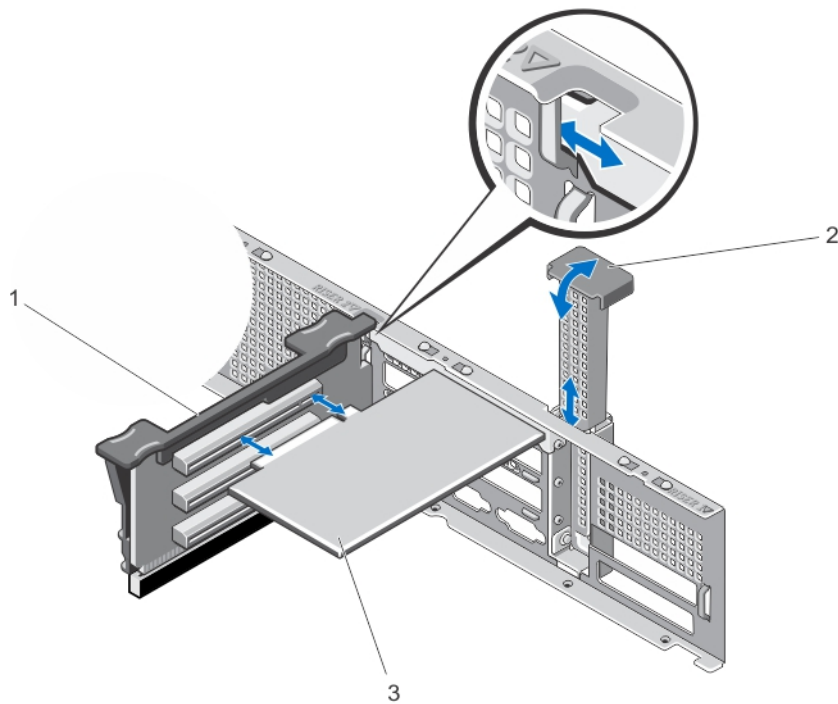

**Figure 31. Removing and Installing the Expansion Card from Expansion-Card Riser 2**

1. riser 2
2. expansion-card latch
3. expansion card

## Installing An Expansion Card

**⚠ CAUTION:** Many repairs may only be done by a certified service technician. You should only perform troubleshooting and simple repairs as authorized in your product documentation, or as directed by the online or telephone service and support team. Damage due to servicing that is not authorized by Dell is not covered by your warranty. Read and follow the safety instructions that came with the product.

1. Unpack the expansion card and prepare it for installation.  
For instructions, see the documentation accompanying the card.
2. Turn off the system, including any attached peripherals, and disconnect the system from the electrical outlet and peripherals.
3. Open the system.
4. Locate the expansion-card connector on the riser.
5. Open the expansion-card latch and remove the filler bracket.
6. If you are installing a full-length, full-height expansion card on slot 2 of the expansion-card riser 2, open the expansion-card holder on the cooling shroud.
7. Holding the card by its edges, position the card so that the card-edge connector aligns with the expansion-card connector.

8. Insert the card-edge connector firmly into the expansion-card connector until the card is fully seated.
9. Slide the expansion-card latch into position.
10. If applicable, connect cables to the expansion card.
11. Close the system.
12. Reconnect the system to its electrical outlet and turn the system on, including any attached peripherals.
13. Install any device drivers required for the card as described in the documentation for the card.

## Removing Expansion-Card Risers

**CAUTION:** Many repairs may only be done by a certified service technician. You should only perform troubleshooting and simple repairs as authorized in your product documentation, or as directed by the online or telephone service and support team. Damage due to servicing that is not authorized by Dell is not covered by your warranty. Read and follow the safety instructions that came with the product.

1. Turn off the system, including any attached peripherals, and disconnect the system from the electrical outlet and peripherals.
2. Open the system.

**NOTE:** Before removing the expansion-card riser, ensure that there are no expansion cards installed on it.

3. Press the release tabs and lift the expansion-card riser from the riser connector on the system board.

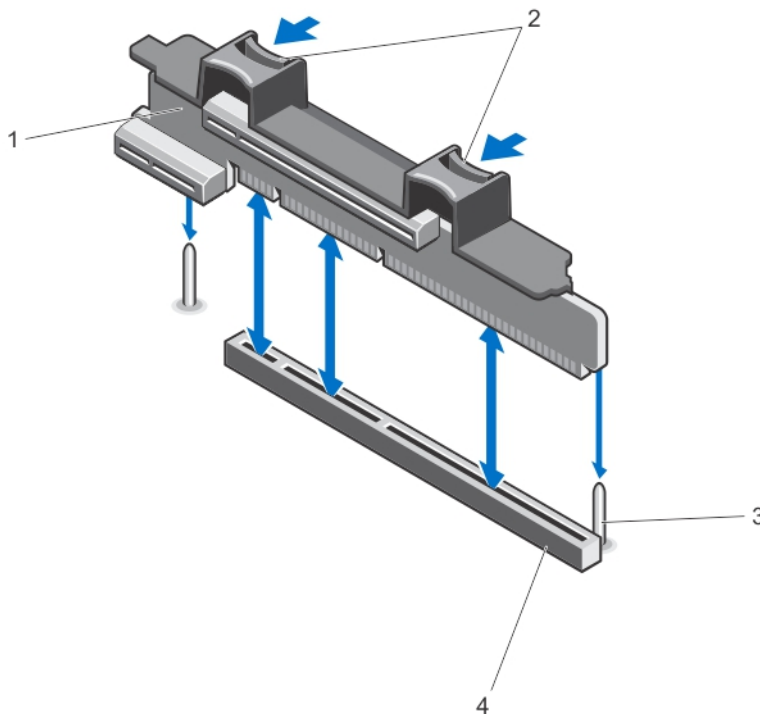

**Figure 32. Removing and Installing the Expansion-Card Riser 1**

1. expansion-card riser 1
2. release tabs (2)
3. riser guide pins (2)
4. connector

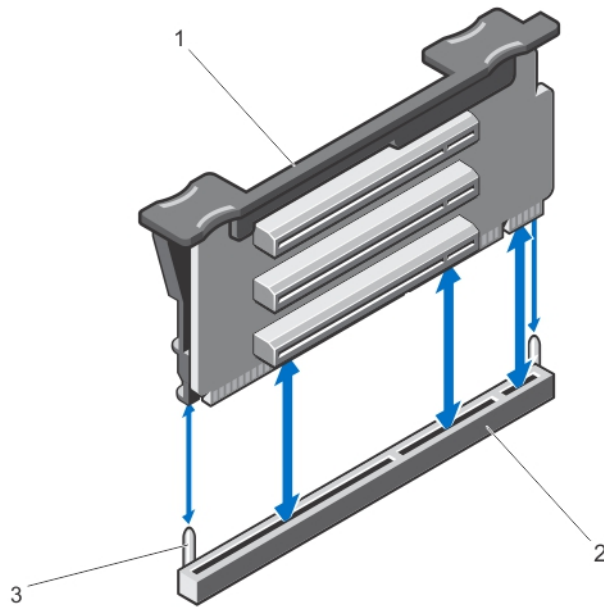

**Figure 33. Removing and Installing the Expansion-Card Riser 2**

1. expansion-card riser 2
2. connector
3. riser guide pins (2)

## Installing Expansion-Card Risers

**⚠ CAUTION:** Many repairs may only be done by a certified service technician. You should only perform troubleshooting and simple repairs as authorized in your product documentation, or as directed by the online or telephone service and support team. Damage due to servicing that is not authorized by Dell is not covered by your warranty. Read and follow the safety instructions that came with the product.

1. If applicable, reinstall the expansion card(s) into the expansion card riser.
2. Align the expansion-card riser with the connector and the riser guide pin on the system board.
3. Lower the expansion-card riser into place until the expansion-card riser connector is fully seated in the connector.
4. Close the system.
5. Reconnect the system to its electrical outlet and turn the system on, including any attached peripherals.
6. Install any device drivers required for the card as described in the documentation for the card.

## iDRAC Ports Card (Optional)

The iDRAC Ports card supports:

- one 1GbE Ethernet port
- SD vFlash card

## Removing The iDRAC Ports Card

 **CAUTION:** Many repairs may only be done by a certified service technician. You should only perform troubleshooting and simple repairs as authorized in your product documentation, or as directed by the online or telephone service and support team. Damage due to servicing that is not authorized by Dell is not covered by your warranty. Read and follow the safety instructions that came with the product.

1. Turn off the system, including any attached peripherals, and disconnect the system from the electrical outlet and peripherals.
2. Open the system.
3. Disconnect any cables connected to the iDRAC Ports card.
4. Lift the expansion-card latch
5. Remove the iDRAC Ports card.
6. If installed, remove the expansion card from slot 1 of expansion-card riser 1.
7. Supporting the expansion-card riser, hold the iDRAC Ports card by its edges and remove it from the iDRAC Ports card connector on the riser.
8. If you are removing the card permanently, install a metal filler bracket over the empty expansion slot opening and close the expansion-card latch.

 **NOTE:** You must install a filler bracket over an empty expansion slot to maintain Federal Communications Commission (FCC) certification of the system. The brackets also keep dust and dirt out of the system and aid in proper cooling and airflow inside the system.

9. Close the system.
10. Reconnect the system to its electrical outlet and turn the system on, including any attached peripherals.

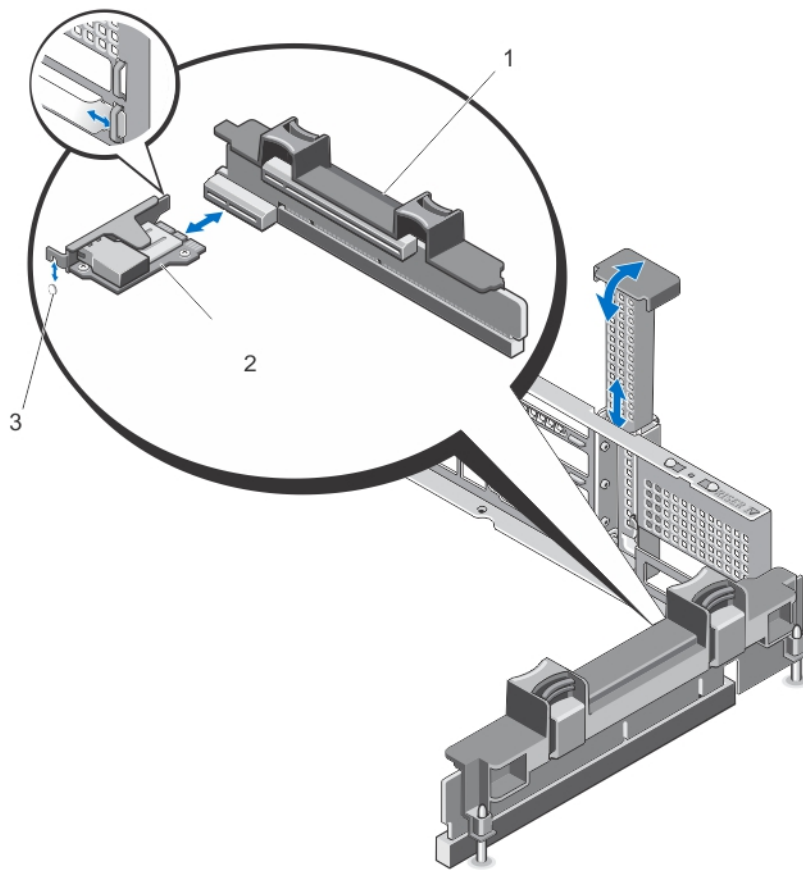

**Figure 34. Removing and Installing the iDRAC Ports Card**

1. expansion-card riser 1
2. iDRAC Ports card
3. iDRAC Ports card alignment slot

## Installing The iDRAC Ports Card

**⚠ CAUTION:** Many repairs may only be done by a certified service technician. You should only perform troubleshooting and simple repairs as authorized in your product documentation, or as directed by the online or telephone service and support team. Damage due to servicing that is not authorized by Dell is not covered by your warranty. Read and follow the safety instructions that came with the product.

1. Unpack the iDRAC Ports card and prepare it for installation.  
For instructions, see the documentation accompanying the card.
2. Turn off the system, including any attached peripherals, and disconnect the system from the electrical outlet and peripherals.
3. Open the system.
4. Locate the iDRAC Ports card connector on expansion-card riser 1.
5. Open the expansion-card latch and remove the filler bracket.

6. Holding the card by its edges, position the card so that the card-edge connector aligns with the iDRAC Ports card connector.
7. Align the iDRAC Ports card bracket with the hooks on the chassis.
8. Insert the card-edge connector firmly into the iDRAC Ports card connector until the card is fully seated.
9. Slide the expansion-card latch into position.
10. If applicable, connect cables to the iDRAC Ports card.
11. Close the system.
12. Reconnect the system to its electrical outlet and turn the system on, including any attached peripherals.
13. Install any device drivers required for the card as described in the documentation for the card.

## SD vFlash Card

A vFlash SD card is a Secure Digital (SD) card that plugs into the vFlash SD card slot in the system. It provides persistent on-demand local storage and a custom deployment environment that allows automation of server configuration, scripts, and imaging. It emulates USB device(s). For more information, see the *iDRAC7 User's Guide* at [dell.com/support/manuals](http://dell.com/support/manuals).

### Replacing An SD vFlash Card

1. Locate the vFlash media slot on the iDRAC Ports card.
2. To remove the installed SD vFlash card, push inward on the card to release it.
3. Pull the card from the card slot.

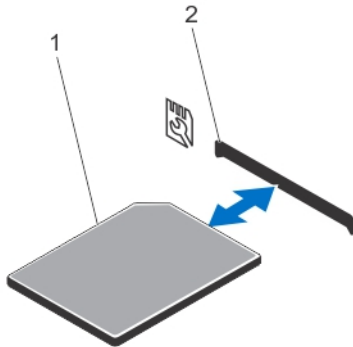

**Figure 35. Removing and Installing the SD vFlash Card**

1. SD vFlash card
2. SD vFlash card slot
4. To install the SD vFlash card, with the label side facing up, insert the contact-pin end of the SD card into the card slot on the module.
  -  **NOTE:** The slot is keyed to ensure correct insertion of the card.
5. Press inward on the card to lock it into the slot.

## Internal Dual SD Module

-  **NOTE:** When the **Redundancy** option is set to **Mirror Mode** in the **Integrated Devices** screen of the System Setup, the information is replicated from one SD card to another.



## Removing The Internal Dual SD Module

**△ CAUTION:** Many repairs may only be done by a certified service technician. You should only perform troubleshooting and simple repairs as authorized in your product documentation, or as directed by the online or telephone service and support team. Damage due to servicing that is not authorized by Dell is not covered by your warranty. Read and follow the safety instructions that came with the product.

1. Turn off the system, including any attached peripherals, and disconnect the system from the electrical outlet and peripherals.
2. Open the system.
3. Locate the internal dual SD module installed on the IDSDM connector on the system board.
4. If applicable, remove the SD card(s).
5. Holding the tab, pull the dual SD module to remove it from the system board.
6. Close the system.
7. Reconnect the system to its electrical outlet and turn the system on, including any attached peripherals.

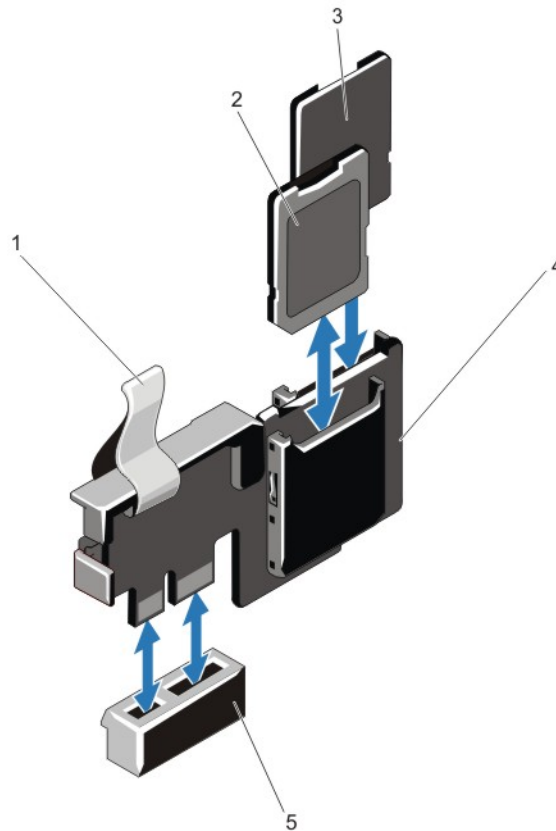

**Figure 36. Removing and Installing the Internal Dual SD Module**

- |                  |                                  |
|------------------|----------------------------------|
| 1. blue pull tab | 4. dual SD module                |
| 2. SD card 1     | 5. connector on the system board |
| 3. SD card 2     |                                  |

## Installing The Internal Dual SD Module

 **CAUTION:** Many repairs may only be done by a certified service technician. You should only perform troubleshooting and simple repairs as authorized in your product documentation, or as directed by the online or telephone service and support team. Damage due to servicing that is not authorized by Dell is not covered by your warranty. Read and follow the safety instructions that came with the product.

1. Turn off the system, including any attached peripherals, and disconnect the system from the electrical outlet and peripherals.
2. Open the system.
3. Locate the connector on the system board.
4. Align the connectors on the system board and the dual SD module.
5. Holding the tab, push the dual SD module until it is firmly seated on the system board.

 **NOTE:** An L-shaped flange extended from the power supply unit cage supports the dual SD module.

6. Close the system.
7. Reconnect the system to its electrical outlet and turn the system on, including any attached peripherals.

## Internal SD Card

### Removing An Internal SD Card

 **CAUTION:** Many repairs may only be done by a certified service technician. You should only perform troubleshooting and simple repairs as authorized in your product documentation, or as directed by the online or telephone service and support team. Damage due to servicing that is not authorized by Dell is not covered by your warranty. Read and follow the safety instructions that came with the product.

1. Turn off the system, including any attached peripherals, and disconnect the system from the electrical outlet and peripherals.
2. Open the system.
3. Locate the SD card slot on the internal dual SD module or the backplane expander board and press inward on the card to release it from the slot and remove the card.
4. Close the system.
5. Reconnect the system to its electrical outlet and turn the system on, including any attached peripherals.

### Installing An Internal SD Card

 **CAUTION:** Many repairs may only be done by a certified service technician. You should only perform troubleshooting and simple repairs as authorized in your product documentation, or as directed by the online or telephone service and support team. Damage due to servicing that is not authorized by Dell is not covered by your warranty. Read and follow the safety instructions that came with the product.

 **NOTE:** To use an SD card with your system, ensure that the internal SD card port is enabled in the System Setup.

1. Turn off the system, including any attached peripherals, and disconnect the system from the electrical outlet and peripherals.
2. Open the system.
3. Locate the SD card connector on the internal dual SD module or the backplane expander board. With the label side facing up, insert the contact-pin end of the card into the slot.

 **NOTE:** The slot is keyed to ensure correct insertion of the card.

4. Press the card into the card slot to lock it into place.
5. Close the system.
6. Reconnect the system to its electrical outlet and turn the system on, including any attached peripherals.

## Integrated Storage Controller Card

Your system supports an integrated storage controller card that provides the integrated storage subsystem for your system's internal hard drives. The controller supports SAS and SATA hard drives and also enables you to set up the hard drives in RAID configurations as supported by the version of the storage controller included with your system.

### Removing The Integrated Storage Controller

 **CAUTION:** Many repairs may only be done by a certified service technician. You should only perform troubleshooting and simple repairs as authorized in your product documentation, or as directed by the online or telephone service and support team. Damage due to servicing that is not authorized by Dell is not covered by your warranty. Read and follow the safety instructions that came with the product.

1. Turn off the system, including any attached peripherals, and disconnect the system from the electrical outlet.
2. Open the system.

 **NOTE:** For easy access to the integrated storage controller, remove the expansion-card riser 2 before removing the integrated storage controller. See Removing Expansion-Card Risers.

3. Push down the two release levers at the edge of the card to disengage the card from the connector.  
As the card releases from the standoffs, the connector under the card disengages from the system board connector.
4. Disengage the card from the storage-controller card holder on the system board.
5. Remove the storage-controller card from the system.
6. Close the system.

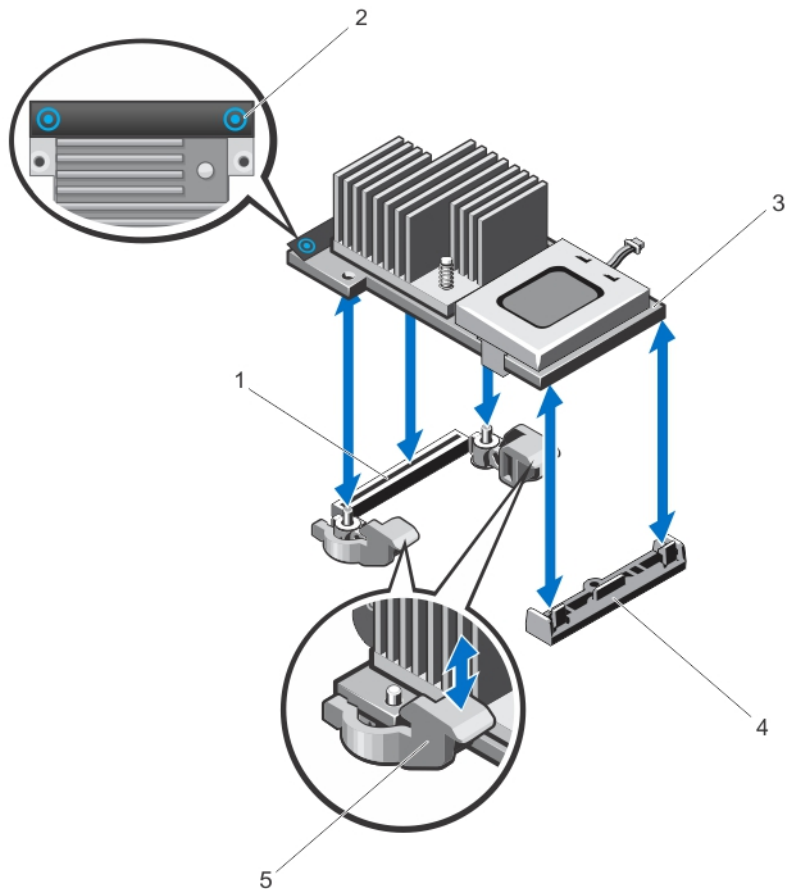

**Figure 37. Removing and Installing the Integrated Storage Controller**

- |  |                                   |
|--|-----------------------------------|
| 1. storage connector on the system board | 4. storage-controller card holder |
| 2. touch-points (2)                      | 5. release levers (2)             |
| 3. storage-controller card               |                                   |

## Installing The Integrated Storage Controller

**⚠ CAUTION:** Many repairs may only be done by a certified service technician. You should only perform troubleshooting and simple repairs as authorized in your product documentation, or as directed by the online or telephone service and support team. Damage due to servicing that is not authorized by Dell is not covered by your warranty. Read and follow the safety instructions that came with the product.

1. Turn off the system, including any attached peripherals, and disconnect the system from the electrical outlet.
2. Open the system.
3. Align one end of the card with the card holder on the system board.
4. Lower the other end of the card and align the holes on the card with the locating posts of the extractors on the system board.
5. Press the card down at the corners until it is fully seated.  
When the card is fully seated, the plastic standoff tab snaps over the edge of the holder.

6. Close the system.
7. Reconnect the system to its electrical outlet and turn the system on, including any attached peripherals.

## Processors

Use the following procedure when:

- Installing an additional processor
- Replacing a processor

### Removing A Processor

 **CAUTION:** Many repairs may only be done by a certified service technician. You should only perform troubleshooting and simple repairs as authorized in your product documentation, or as directed by the online or telephone service and support team. Damage due to servicing that is not authorized by Dell is not covered by your warranty. Read and follow the safety instructions that came with the product.

1. Before upgrading your system, download the latest system BIOS version from [dell.com/support](http://dell.com/support) and follow the instructions included in the compressed download file to install the update on your system.

 **NOTE:** You can update the system BIOS using the Lifecycle Controller.

2. Turn off the system, including any attached peripherals, and disconnect the system from the electrical outlet. When disconnected from the power source, press and hold the power button for three seconds to fully drain the system of stored power prior to removing the cover.
3. Open the system.
4. Remove the cooling shroud.

 **WARNING:** The heat sink and processor are hot to the touch for some time after the system has been powered down. Allow the heat sink and processor to cool before handling them.

 **CAUTION:** Never remove the heat sink from a processor unless you intend to remove the processor. The heat sink is necessary to maintain proper thermal conditions.

5. Using a #2 Phillips screwdriver, loosen one of the heat-sink retention sockets. Wait 30 seconds for the heat sink to loosen from the processor.
6. Loosen the other three heat-sink retention sockets.
7. Lift the heat sink away from the processor.

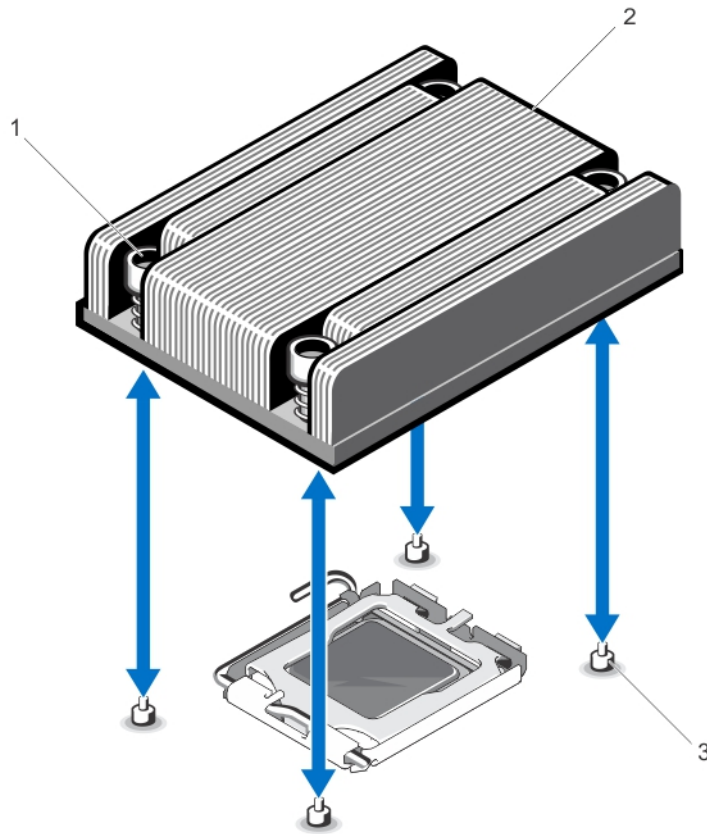

**Figure 38. Removing and Installing the Heat Sink**

1. retention sockets (4)
2. heat sink
3. retention screws (4)

**⚠ CAUTION: The processor is held in its socket under strong pressure. Be aware that the release lever can spring up suddenly if not firmly grasped.**

8. Position your thumb firmly over the processor socket-release lever and release the lever from the locked position.
9. Rotate the lever 90 degrees upward until the processor is released from the socket.
10. Rotate the processor shield upward and out of the way.

**⚠ CAUTION: The socket pins are fragile and can be permanently damaged. Be careful not to bend the pins in the socket when removing the processor out of the socket.**

11. Lift the processor out of the socket and leave the release lever up so that the socket is ready for the new processor.

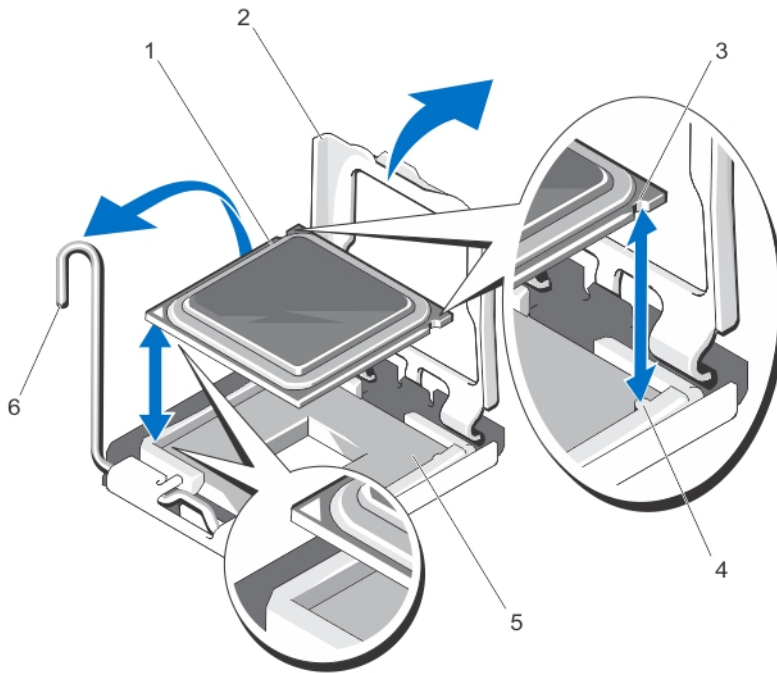

**Figure 39. Removing and Installing a Processor**

- |                             |                         |
|-----------------------------|-------------------------|
| 1. processor                | 5. ZIF socket           |
| 2. processor shield         | 6. socket-release lever |
| 3. notches in processor (4) |                         |
| 4. socket keys (4)          |                         |

**NOTE:** After removing the processor, place it in an antistatic container for reuse, return, or temporary storage. Do not touch the bottom of the processor. Touch only the side edges of the processor.

## Installing A Processor

**CAUTION:** Many repairs may only be done by a certified service technician. You should only perform troubleshooting and simple repairs as authorized in your product documentation, or as directed by the online or telephone service and support team. Damage due to servicing that is not authorized by Dell is not covered by your warranty. Read and follow the safety instructions that came with the product.

**NOTE:** If you install a second processor, you must:

- remove the dummy fan from the FAN6 slot
  - install a cooling fan in the FAN6 slot
  - upgrade both the expansion-card risers (riser 1 and riser 2)
1. Before upgrading your system, download the latest system BIOS version from [dell.com/support](http://dell.com/support) and follow the instructions included in the compressed download file to install the update on your system.

 **NOTE:** You can update the system BIOS using the Lifecycle Controller.

2. Turn off the system, including any attached peripherals, and disconnect the system from the electrical outlet. When disconnected from power, press and hold the power button for three seconds to fully drain the system of stored power prior to removing the cover.
3. Open the system.
4. Remove the cooling shroud.

 **WARNING:** The heat sink and processor are hot to the touch for some time after the system has been powered down. Allow the heat sink and processor to cool before handling them.

 **CAUTION:** Never remove the heat sink from a processor unless you intend to remove the processor. The heat sink is necessary to maintain proper thermal conditions.

5. Position your thumb firmly over the processor socket-release lever and release the lever from the locked position.
6. Rotate the lever 90 degrees upward.
7. Rotate the processor shield upward and out of the way.
8. Unpack the new processor.
9. With the release lever on the processor socket in the open position, align the processor with the socket keys on the ZIF socket.

 **CAUTION:** Positioning the processor incorrectly can permanently damage the system board or the processor. Be careful not to bend the pins in the socket.

 **CAUTION:** Do not use force to seat the processor. When the processor is positioned correctly, it engages easily into the socket.

10. Set the processor lightly in the socket.
11. Close the processor shield.
12. Rotate the socket release lever down until it locks into position.
13. Using a clean lint-free cloth, remove the thermal grease from the heat sink.

 **CAUTION:** Applying too much thermal grease can result in excess grease coming in contact with and contaminating the processor socket.

14. Open the grease applicator included with your processor kit and apply all of the thermal grease in the applicator to the center of the topside of the new processor.
15. Place the heat sink on the processor.
16. Using a #2 Phillips screwdriver, tighten the heat-sink retention sockets.
17. Install the cooling shroud.
18. Close the system.
19. Reconnect your system and peripherals to their electrical outlets, and turn on the system.
20. Press <F2> to enter the System Setup and check that the processor information matches the new system configuration.
21. Run the system diagnostics to verify that the new processor operates correctly.

## Power Supplies

Your system supports:

- Two 495 W, 750 W, or 1100 W AC power supply modules
- One cabled power supply module 550 W (non-redundant)
- Two 750 W or 1100 W DC power supply modules



- When two identical power supplies are installed, the power supply configuration is redundant (1 + 1). In redundant mode, power is supplied to the system equally from both power supplies to maximize efficiency.
- When only one power supply is installed, the power supply configuration is non-redundant (1 + 0). Power is supplied to the system only by the single power supply.

 **NOTE:** If two power supplies are used, they must be of the same type and have the same maximum output power.

 **NOTE:** Titanium power supply is nominally rated for 200 VAC to 240 VAC input only.

 **CAUTION:** Do not operate your system with only one 1100 W AC or DC power supply installed.

## Removing An AC Power Supply

 **CAUTION:** Many repairs may only be done by a certified service technician. You should only perform troubleshooting and simple repairs as authorized in your product documentation, or as directed by the online or telephone service and support team. Damage due to servicing that is not authorized by Dell is not covered by your warranty. Read and follow the safety instructions that came with the product.

 **CAUTION:** The system requires one power supply for normal operation. On power-redundant systems, remove and replace only one power supply at a time in a system that is powered on.

 **NOTE:** You may have to unlatch and lift the optional cable management arm if it interferes with power supply removal. For information about the cable management arm, see the system's rack documentation.

1. Disconnect the power cable from the power source and the power supply you intend to remove and remove the cables from the strap.
2. Press the release latch and slide the power supply out of the chassis.

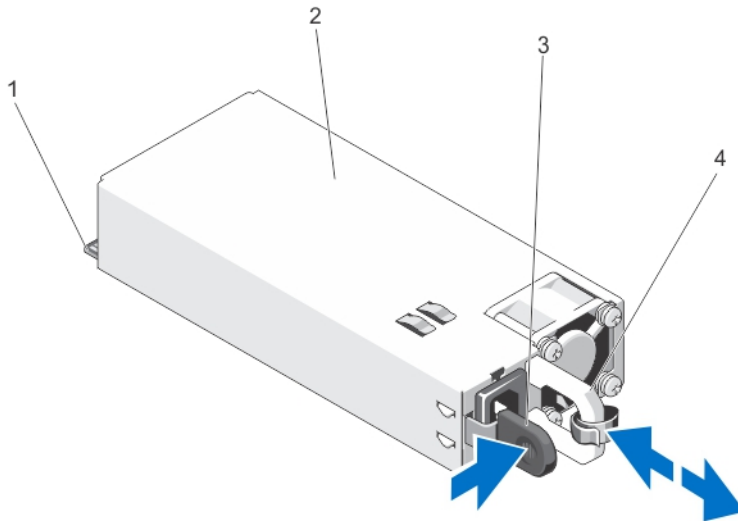

**Figure 40. Removing and Installing an AC Power Supply**

1. connector
2. power supply
3. release latch
4. power supply handle

## Installing An AC Power Supply

 **CAUTION:** Many repairs may only be done by a certified service technician. You should only perform troubleshooting and simple repairs as authorized in your product documentation, or as directed by the online or telephone service and support team. Damage due to servicing that is not authorized by Dell is not covered by your warranty. Read and follow the safety instructions that came with the product.

1. Verify that both the power supplies are the same type and have the same maximum output power.

 **NOTE:** The maximum output power (shown in Watts) is listed on the power supply label.

2. If applicable, remove the power supply blank.
3. Slide the new power supply into the chassis until the power supply is fully seated and the release latch snaps into place.

 **NOTE:** If you unlatched the cable management arm, re-latch it. For information about the cable management arm, see the system's rack documentation.

4. Connect the power cable to the power supply and plug the cable into a power outlet.

 **CAUTION:** When connecting the power cable, secure the cable with the strap.

 **NOTE:** When installing, hot-swapping, or hot-adding a new power supply, allow several seconds for the system to recognize the power supply and determine its status. The power-supply status indicator turns green to signify that the power supply is functioning properly.

## Wiring Instructions For A DC Power Supply

Your system supports up to two  $-(48-60)$  V DC power supplies (when available).

 **WARNING:** For equipment using  $-(48-60)$  V DC power supplies, a qualified electrician must perform all connections to DC power and to safety grounds. Do not attempt connecting to DC power or installing grounds yourself. All electrical wiring must comply with applicable local or national codes and practices. Damage due to servicing that is not authorized by Dell is not covered by your warranty. Read and follow all safety instructions that came with the product.

 **CAUTION:** Wire the unit with copper only, unless otherwise specified, use only 10 American Wire Gauge (AWG) wire rated minimum 90 °C for source and return. Protect the  $-(48-60)$  V DC (1 wire) with a branch circuit over-current protection rated 50 A for DC with a high interrupt current rating.

 **NOTE:** A readily accessible disconnect device that is suitably approved and rated shall be incorporated in the field wiring.

### Input Requirements

- Supply voltage:  $-(48-60)$  V DC
- Current consumption: 32 A (maximum)

### Kit Contents

- Dell part number 6RYJ9 terminal block or equivalent (1)
- #6-32 nut equipped with lock washer (1)

### Required Tools

Wire-stripper pliers capable of removing insulation from size 10 AWG solid or stranded, insulated copper wire

 **NOTE:** Use alpha wire part number 3080 or equivalent (65/30 stranding)

### Required Wires

- One UL 10 AWG, 2 m maximum (stranded) black wire [–(48–60) V DC]
- One UL 10 AWG, 2 m maximum (stranded) red wire (V DC return)
- One UL 10 AWG, 2 m maximum green/yellow, green with a yellow stripe, stranded wire (safety ground)

### Assembling And Connecting The Safety Ground Wire

 **WARNING:** For equipment using –(48–60) V DC power supplies, a qualified electrician must perform all connections to DC power and to safety grounds. Do not attempt connecting to DC power or installing grounds yourself. All electrical wiring must comply with applicable local or national codes and practices. Damage due to servicing that is not authorized by Dell is not covered by your warranty. Read and follow all safety instructions that came with the product.

1. Strip the insulation from the end of the green/yellow wire, exposing approximately 4.5 mm (0.175 inch) of copper wire.
2. Using a hand-crimping tool (Tyco Electronics, 58433-3 or equivalent), crimp the ring-tongue terminal (Jeason Terminals Inc., R5-4SA or equivalent) to the green/yellow wire (safety ground wire).
3. Connect the safety ground wire to the grounding post on the back of the system using a #6-32 nut equipped with a locking washer.

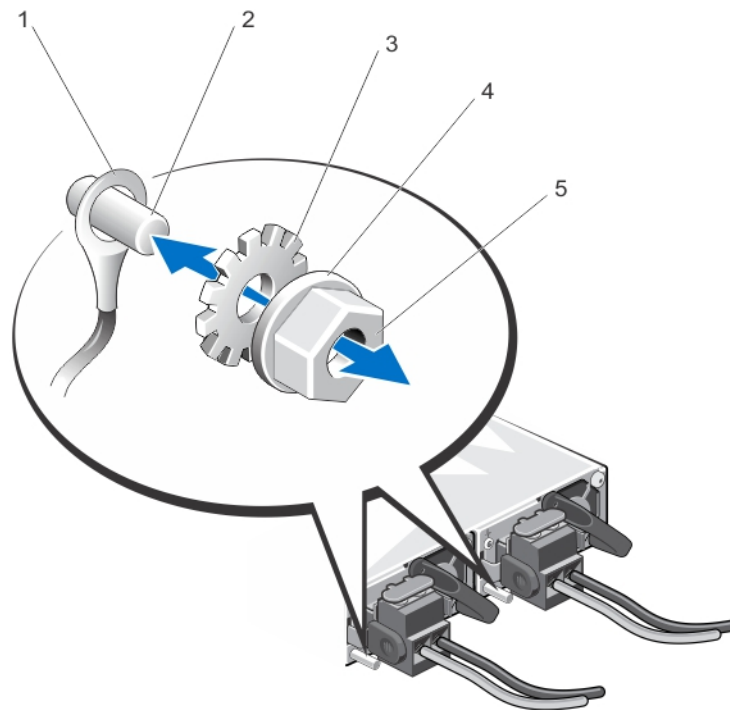

**Figure 41. Assembling and Connecting the Safety Ground Wire**

- |                       |                  |
|-----------------------|------------------|
| 1. safety ground wire | 4. spring washer |
| 2. grounding post     | 5. #6-32 nut     |
| 3. locking washer     |                  |

## Assembling The DC Input Power Wires

**⚠ WARNING:** For equipment using  $-(48-60)$  V DC power supplies, a qualified electrician must perform all connections to DC power and to safety grounds. Do not attempt connecting to DC power or installing grounds yourself. All electrical wiring must comply with applicable local or national codes and practices. Damage due to servicing that is not authorized by Dell is not covered by your warranty. Read and follow all safety instructions that came with the product.

1. Strip the insulation from the ends of the DC power wires, exposing approximately 13 mm (0.5 inch) of copper wire.

**⚠ WARNING:** Reversing polarity when connecting DC power wires can permanently damage the power supply or the system.

2. Insert the copper ends into the mating connectors and tighten the captive screws at the top of the mating connector using a #2 Phillips screwdriver.

**⚠ WARNING:** To protect the power supply from electrostatic discharge, the captive screws must be covered with the rubber cap before inserting the mating connector into the power supply.

3. Rotate the rubber cap clockwise to fix it over the captive screws.
4. Insert the mating connector into the power supply.

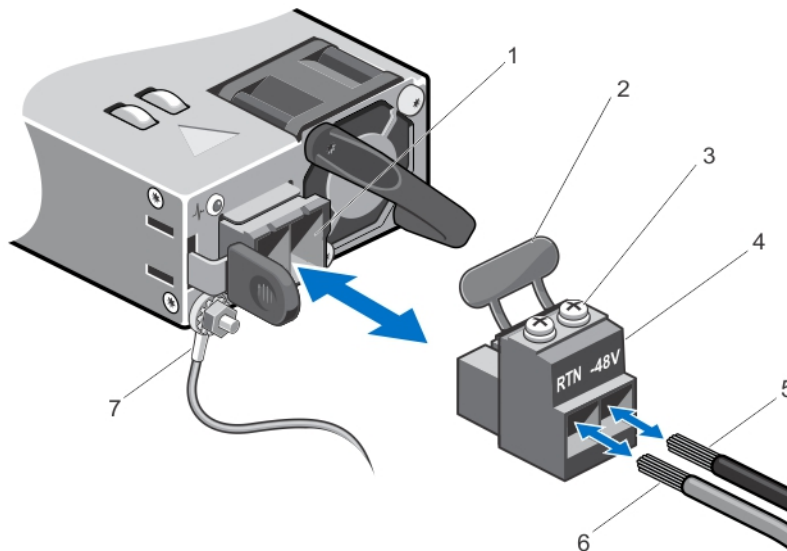

**Figure 42. Assembling the DC Input Power Wires**

- |                       |                   |
|-----------------------|-------------------|
| 1. DC power socket    | 5. wire $-48$ V   |
| 2. rubber cap         | 6. wire RTN       |
| 3. captive screws (2) | 7. grounding wire |
| 4. DC power connector |                   |

## Removing A DC Power Supply

**⚠ WARNING:** For equipment using  $-(48-60)$  V DC power supplies, a qualified electrician must perform all connections to DC power and to safety grounds. Do not attempt connecting to DC power or installing grounds yourself. All electrical wiring must comply with applicable local or national codes and practices. Damage due to servicing that is not authorized by Dell is not covered by your warranty. Read and follow all safety instructions that came with the product.

**⚠ CAUTION:** The system requires one power supply for normal operation. On power-redundant systems, remove and replace only one power supply at a time in a system that is powered on.

**🔧 NOTE:** You may have to unlatch and lift the optional cable management arm if it interferes with power supply removal. For information about the cable management arm, see the system's rack documentation.

1. Disconnect the power wires from the power source and the connector from the power supply you intend to remove.
2. Disconnect the safety ground wire.
3. Press the release latch and slide the power supply out of the chassis.

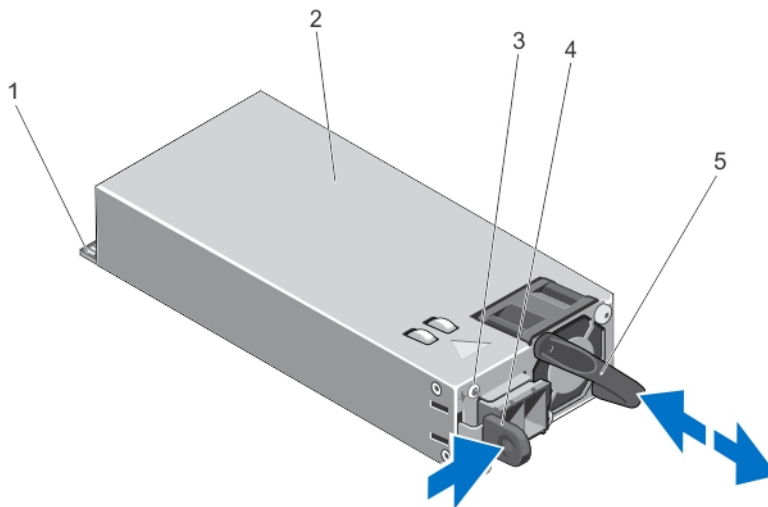





Figure 43. Removing and Installing a DC Power Supply

- |                                  |                        |
|----------------------------------|------------------------|
| 1. connector                     | 4. release latch       |
| 2. power supply                  | 5. power supply handle |
| 3. power supply status indicator |                        |

## Installing A DC Power Supply

**⚠ WARNING:** For equipment using  $-(48-60)$  V DC power supplies, a qualified electrician must perform all connections to DC power and to safety grounds. Do not attempt connecting to DC power or installing grounds yourself. All electrical wiring must comply with applicable local or national codes and practices. Damage due to servicing that is not authorized by Dell is not covered by your warranty. Read and follow all safety instructions that came with the product.

1. Verify that both the power supplies are the same type and have the same maximum output power.

-  **NOTE:** The maximum output power (shown in Watts) is listed on the power supply label.
- If applicable, remove the power supply blank.
  - Slide the new power supply into the chassis until the power supply is fully seated and the release latch snaps into place.
-  **NOTE:** If you unlatched the cable management arm, re-latch it. For information about the cable management arm, see the system's rack documentation.
- Connect the safety ground wire.
  - Install the DC power connector in the power supply.
-  **CAUTION:** When connecting the power wires, secure the wires with the strap to the power supply handle.
- Connect the wires to a DC power source.
-  **NOTE:** When installing, hot-swapping, or hot-adding a new power supply, allow several seconds for the system to recognize the power supply and determine its status. The power-supply status indicator turns green to signify that the power supply is functioning properly.

## Removing The Power Supply Blank

-  **CAUTION:** To ensure proper system cooling, the power supply blank must be installed in the second power supply bay in a non-redundant configuration. Remove the power supply blank only if you are installing a second power supply.

If you are installing a second power supply, remove the power supply blank in the bay by pulling outward on the blank.

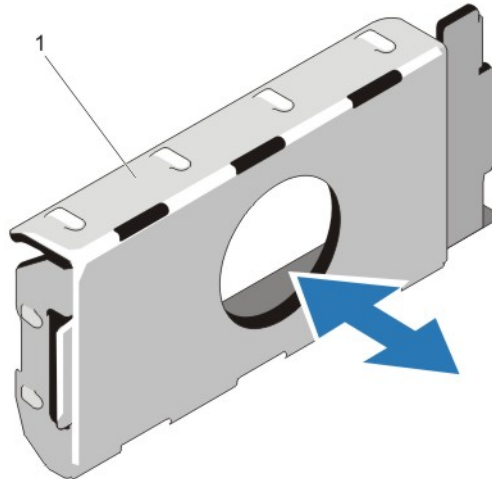

**Figure 44. Removing and Installing the Power Supply Blank**

- power supply blank

## Installing The Power Supply Blank

-  **NOTE:** Install the power supply blank only in the second power supply bay.

To install the power supply blank, align the blank with the power supply bay and insert it into the chassis until it clicks into place.

## Removing The Power-Distribution And Power-Interposer Boards

**⚠ CAUTION:** Many repairs may only be done by a certified service technician. You should only perform troubleshooting and simple repairs as authorized in your product documentation, or as directed by the online or telephone service and support team. Damage due to servicing that is not authorized by Dell is not covered by your warranty. Read and follow the safety instructions that came with the product.

1. Turn off the system, including any attached peripherals, and disconnect the system from the electrical outlet and peripherals
2. Disconnect the power cable from the power source and the power supply you intend to remove, and remove the cables from the strap.
3. Open the system.
4. Disconnect all the power cables from the power supply to the system board, hard drives, and optical drive.

**⚠ CAUTION:** The power-distribution and the power-interposer board assembly must be removed from the system before separating them to avoid damaging the power-distribution board's bottom layout.

5. Remove the screws securing the power-distribution board to the chassis.
6. Keeping the release tab pressed, slide the power-interposer and power-distribution board assembly up and toward the cooling fan, and lift it out of the system.
7. Pull the power-distribution board out from the power-distribution board connector on the power-interposed board.

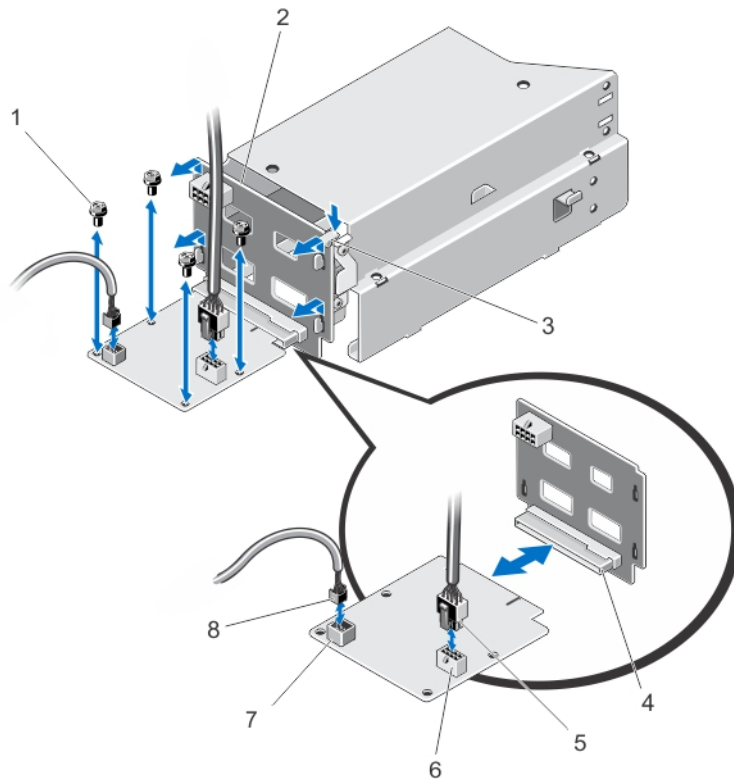

**Figure 45. Removing and Installing the Power-Distribution Board**

1. power-distribution board
2. fan 6 cable connector

- 3. screws (4)
- 4. power-interposer board
- 5. release tab
- 6. power-distribution board connector

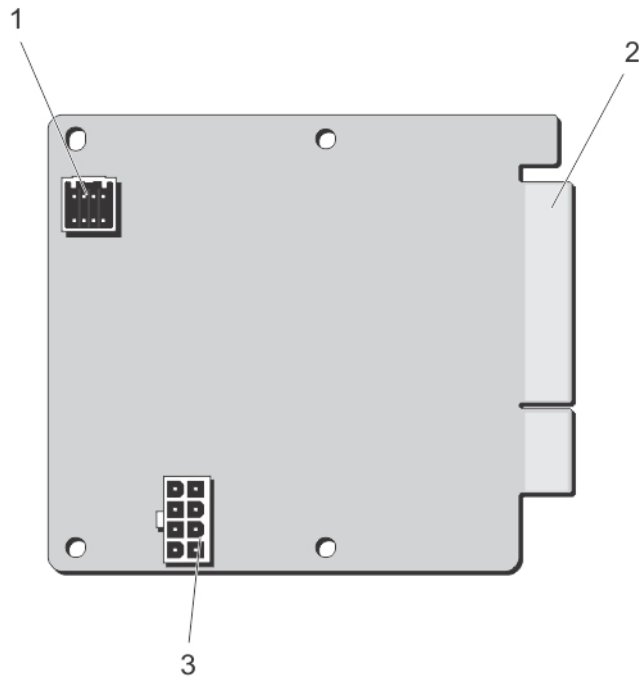

**Figure 46. Power-Distribution Board Connectors**

- 1. fan 6 cable connector
- 2. power-distribution board connector
- 3. 8-pin power connector



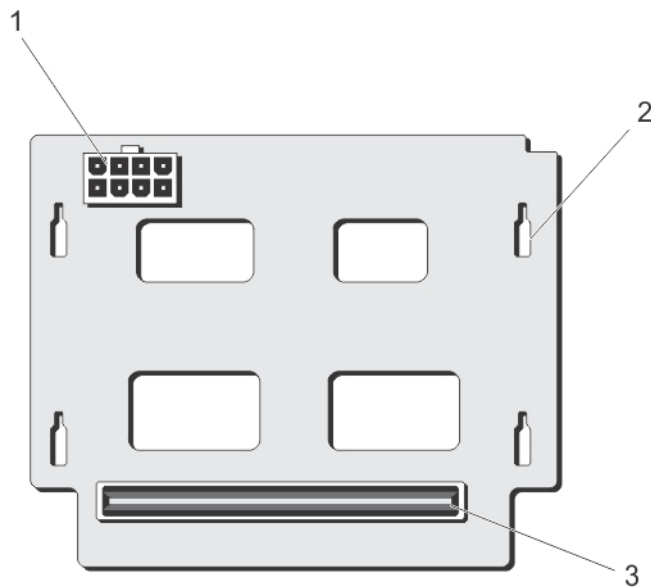

**Figure 47. Power-Interposer Board Connectors**

1. 8-pin power connector
2. retaining slots (4)
3. power-distribution board connector

## Installing The Power-Distribution And Power-Interposer Boards

**CAUTION:** Many repairs may only be done by a certified service technician. You should only perform troubleshooting and simple repairs as authorized in your product documentation, or as directed by the online or telephone service and support team. Damage due to servicing that is not authorized by Dell is not covered by your warranty. Read and follow the safety instructions that came with the product.

1. Unpack the new power-distribution and power-interposer boards.
2. Open the system.
3. Connect the power-distribution board to the power-interposer board outside the system

**CAUTION:** To avoid damaging the power-distribution board's bottom layout, always connect the power-distribution board to the power-interposer board outside the system.

4. Slide the power-interposer and power-distribution board assembly into the retaining hooks and push the boards downward until it clicks into position.
5. Install the four screws that secure the power-distribution board to the chassis.
6. Connect the power-distribution cables to the system board, the fan cable to the power-distribution board, and the power cable to the power-interposer board.
7. Install the power supplies in the system.
8. Close the system.
9. Reconnect the system to its electrical outlet and turn the system on, including any attached peripherals.

## Removing A Non-Redundant Power Supply

 **CAUTION:** Many repairs may only be done by a certified service technician. You should only perform troubleshooting and simple repairs as authorized in your product documentation, or as directed by the online or telephone service and support team. Damage due to servicing that is not authorized by Dell is not covered by your warranty. Read and follow the safety instructions that came with the product.

 **NOTE:** You may have to unlatch and lift the optional cable management arm if it interferes with power supply removal. For information about the cable management arm, see the system's rack documentation.

1. Turn off the system, including any attached peripherals, and disconnect the system from the electrical outlet and peripherals
2. Disconnect the power cable from the power source and the power supply you intend to remove, and remove the cables from the strap.
3. Open the system.
4. Disconnect the power cables from the power supply to the system board, and the hard-drive backplane.
5. Remove the screw securing the power supply to the standoff on the chassis.
6. Slide the power supply out of the chassis and away from the system.

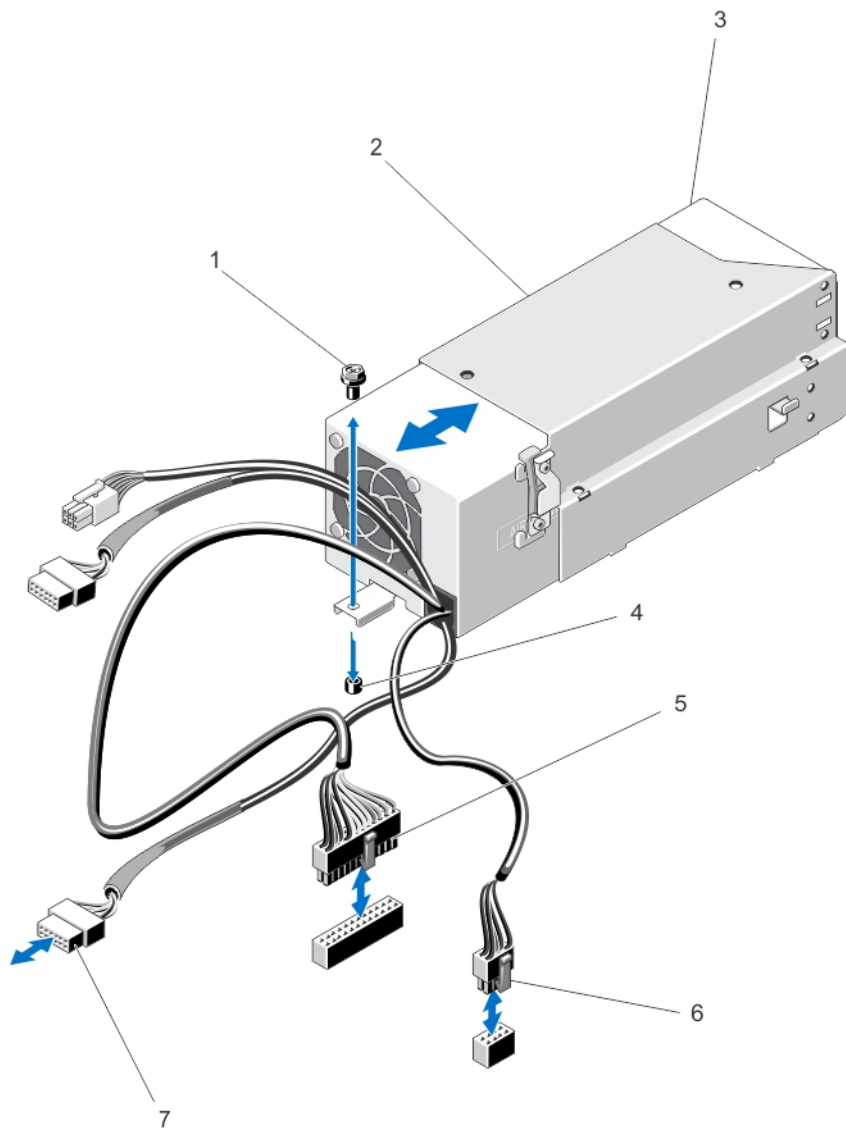

**Figure 48. Removing and Installing a Non-Redundant Power Supply**

- |                            |                                     |
|----------------------------|-------------------------------------|
| 1. chassis screw           | 5. power cable (24 pins)            |
| 2. power supply unit cage  | 6. power cable (8 pins)             |
| 3. power supply            | 7. hard-drive backplane power cable |
| 4. standoff on the chassis |                                     |

## Installing A Non-Redundant Power Supply

 **CAUTION:** Many repairs may only be done by a certified service technician. You should only perform troubleshooting and simple repairs as authorized in your product documentation, or as directed by the online or telephone service and support team. Damage due to servicing that is not authorized by Dell is not covered by your warranty. Read and follow the safety instructions that came with the product.

1. Unpack the new non-redundant power supply unit.
2. Open the system.
3. Slide the new power supply into the chassis until the screw hole on the power supply unit aligns with the standoff on the chassis.
4. Tighten the screw to secure the power supply to the standoff on the chassis.
5. Connect the power cable to the power supply.
6. Connect the power distribution cables to the system board, and the hard-drive backplane.

 **NOTE:** Route the hard-drive backplane power cable through the **FAN1** slot's fan blank.

7. Close the system.
8. Reconnect the system to its electrical outlet and turn the system on, including any attached peripherals.

## Removing The Redundant Power Supply Unit Divider

 **CAUTION:** Many repairs may only be done by a certified service technician. You should only perform troubleshooting and simple repairs as authorized in your product documentation, or as directed by the online or telephone service and support team. Damage due to servicing that is not authorized by Dell is not covered by your warranty. Read and follow the safety instructions that came with the product.

1. Turn off the system, including any attached peripherals, and disconnect the system from the electrical outlet and peripherals
2. Disconnect the power cable from the power source and the power supplies, and remove the cables from the strap.
3. Remove the redundant power supplies.
4. Open the system.
5. Remove the screw securing the redundant power supply unit divider to the power supply unit cage.
6. Slide the redundant power supply unit divider out, push it down, and slide it out of the power supply unit cage.

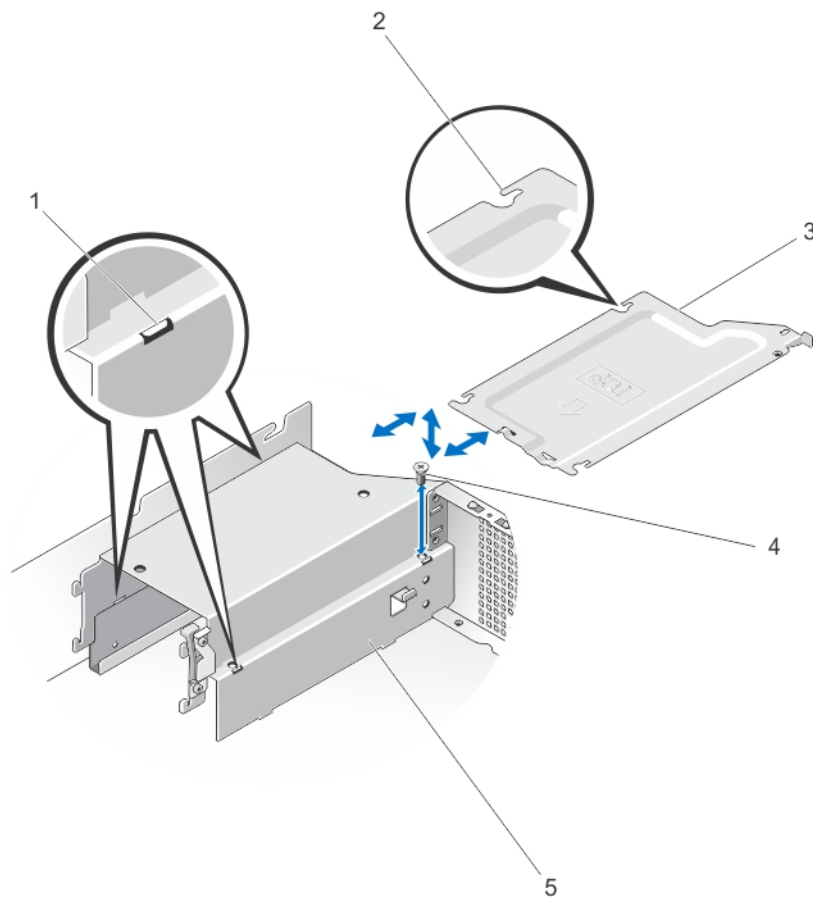

**Figure 49. Removing and Installing the Redundant Power-Supply Unit Divider**

- |  |                                 |
|--|---------------------------------|
| 1. power supply unit divider alignment notches (3) | 4. power supply unit cage screw |
| 2. power supply unit divider alignment tabs (3)    | 5. power supply unit cage       |
| 3. redundant power supply unit divider             |                                 |

## Installing The Redundant Power Supply Unit Divider

**⚠ CAUTION:** Many repairs may only be done by a certified service technician. You should only perform troubleshooting and simple repairs as authorized in your product documentation, or as directed by the online or telephone service and support team. Damage due to servicing that is not authorized by Dell is not covered by your warranty. Read and follow the safety instructions that came with the product.

1. Turn off the system, including any attached peripherals, and disconnect the system from the electrical outlet and peripherals
2. Disconnect the power cable from the power source and the power supplies, and remove the cables from the strap.
3. Open the system.
4. Disconnect all the power cables from the power supply to the system board, hard drives and optical drive.

5. Remove the non-redundant power supplies from the system.
6. Install the redundant power supply unit divider:
  - a) Slide the redundant power supply unit divider into the power supply unit cage.
  - b) Align the power supply unit divider with the notches on the power supply unit cage.
  - c) Push the power supply unit divider up, and slide it into the power supply unit cage.
  - d) Install the screw to secure the redundant power supply unit divider to the power supply unit cage.
7. Install the redundant power supplies in the system.
8. Connect the power-distribution cables to the system board, the fan cable to the power-distribution board, and the power cable to the power-interposer board.
9. Close the system.
10. Reconnect the system to its electrical outlet and turn the system on, including any attached peripherals.

## System Battery

### Replacing The System Battery

**⚠ WARNING:** There is a danger of a new battery exploding if it is incorrectly installed. Replace the battery only with the same or equivalent type recommended by the manufacturer. See your safety information for additional information.

**⚠ CAUTION:** Many repairs may only be done by a certified service technician. You should only perform troubleshooting and simple repairs as authorized in your product documentation, or as directed by the online or telephone service and support team. Damage due to servicing that is not authorized by Dell is not covered by your warranty. Read and follow the safety instructions that came with the product.

1. Turn off the system, including any attached peripherals, and disconnect the system from the electrical outlet and peripherals.
2. Open the system.

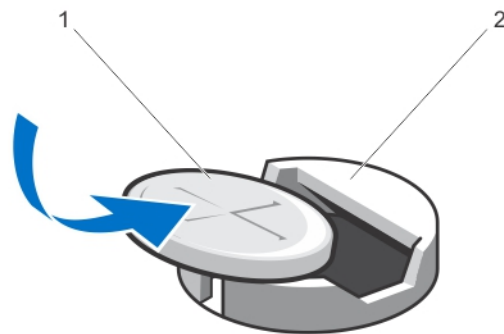

**Figure 50. Replacing the System Battery**

1. system battery
2. battery connector
3. Locate the battery socket.

**⚠ CAUTION:** To avoid damage to the battery connector, you must firmly support the connector while installing or removing a battery.

4. To remove the battery, press down firmly on the positive side of the connector and lift the battery out of the securing tabs at the negative side of the connector.
5. To install a new system battery, hold the battery with the "+" facing up and slide it under the securing tabs at the positive side of the connector.
6. Press the battery straight down into the connector until it snaps into place.
7. Close the system.
8. Reconnect the system to the electrical outlet and turn the system on, including any attached peripherals
9. Enter System Setup to confirm that the battery is operating properly.
10. Enter the correct time and date in the System Setup's **Time** and **Date** fields.
11. Exit System Setup.

## Hard-Drive Backplane

### Removing The Hard-Drive Backplane

 **CAUTION: Many repairs may only be done by a certified service technician. You should only perform troubleshooting and simple repairs as authorized in your product documentation, or as directed by the online or telephone service and support team. Damage due to servicing that is not authorized by Dell is not covered by your warranty. Read and follow the safety instructions that came with the product.**

1. If installed, remove the front bezel.
2. Turn off the system, including any attached peripherals, and disconnect the system from the electrical outlet.
3. Open the system.

 **CAUTION: To prevent damage to the hard drives and hard-drive backplane, you must remove the hard drives from the system before removing the hard-drive backplane.**

 **CAUTION: You must note the number of each hard drive and temporarily label them before removal so that you can replace them in the same locations.**

4. Remove all hard drives.
5. Disconnect the SAS/SATA/SSD data cable(s) and power cable from the hard-drive backplane.
6. Disconnect the power/data cable from the control panel board.
7. Press the hard-drive backplane blue release tabs in the direction of the arrows to disengage the backplane from the chassis.
8. Pull the hard-drive backplane away from the system until the securing hooks on the hard-drive backplane are free from the slots on the chassis.

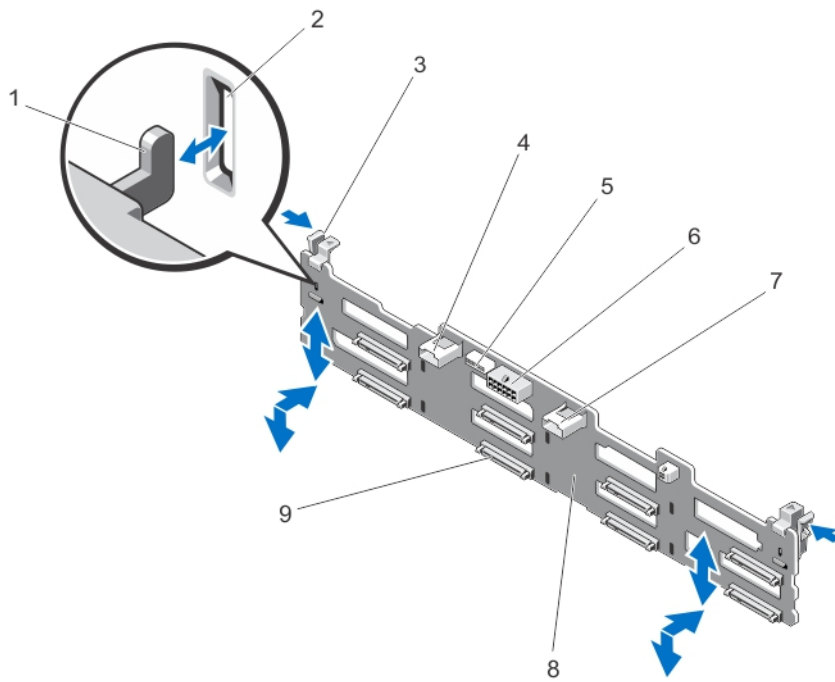

**Figure 51. Removing and Installing the Hard-Drive Backplane**

- |                               |                              |
|-------------------------------|------------------------------|
| 1. securing hooks             | 6. backplane power connector |
| 2. securing slot              | 7. SAS B connector           |
| 3. release tabs (2)           | 8. hard-drive backplane      |
| 4. SAS A connector            | 9. hard-drive connectors (8) |
| 5. backplane signal connector |                              |



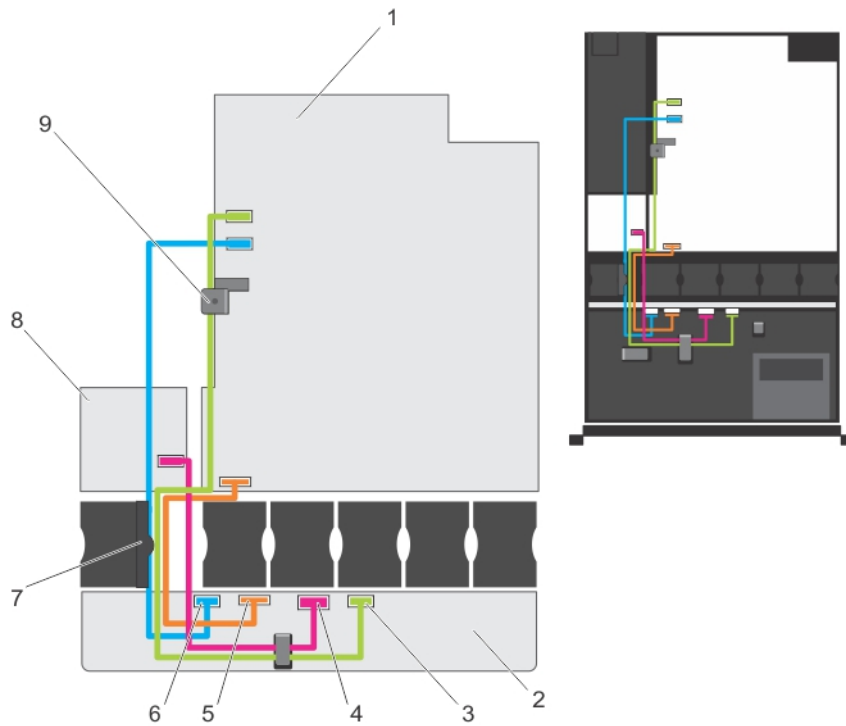

**Figure 52. Cabling Diagram of the Hard-Drive Backplane for a Redundant PSU System**

- |                           |                             |
|---------------------------|-----------------------------|
| 1. system board           | 6. SAS A cable connector    |
| 2. hard-drive backplane   | 7. cable routing guide      |
| 3. SAS B cable connector  | 8. power distribution board |
| 4. power cable connector  | 9. cable retention latch    |
| 5. signal cable connector |                             |

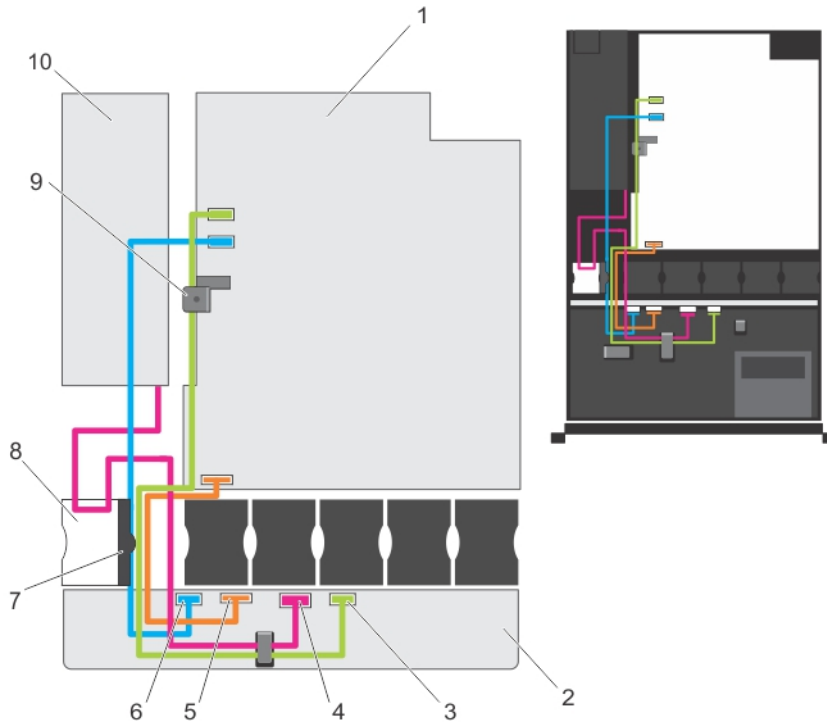

**Figure 53. Cabling Diagram of the Hard-Drive Backplane for a Non-Redundant PSU System**

- |                           |                                |
|---------------------------|--------------------------------|
| 1. system board           | 7. cable routing guide         |
| 2. hard-drive backplane   | 8. FAN1 slot                   |
| 3. SAS B cable connector  | 9. cable retention latch       |
| 4. power cable connector  | 10. non-redundant power supply |
| 5. signal cable connector |                                |
| 6. SAS A cable connector  |                                |

## Installing The Hard-Drive Backplane

**⚠ CAUTION:** Many repairs may only be done by a certified service technician. You should only perform troubleshooting and simple repairs as authorized in your product documentation, or as directed by the online or telephone service and support team. Damage due to servicing that is not authorized by Dell is not covered by your warranty. Read and follow the safety instructions that came with the product.

1. Holding the blue release tabs, align the slots on the hard-drive backplane with the securing hooks on the chassis.
2. Push the hard-drive backplane down until the release tabs snap into place.
3. Attach the SAS A cable to the SAS A connector, and the SAS B cable to the SAS B connector on the hard-drive backplane.
4. Connect the power cable(s) to the hard-drive backplane.
5. Route the power/data cables along the chassis wall.
6. Install the hard drives in their original locations.
7. Close the system.
8. Reconnect the system to its electrical outlet and turn the system on, including any attached peripherals.

9. If applicable, install the front bezel.

## Control Panel Assembly

### Removing The Control-Panel Board

**△ CAUTION:** Many repairs may only be done by a certified service technician. You should only perform troubleshooting and simple repairs as authorized in your product documentation, or as directed by the online or telephone service and support team. Damage due to servicing that is not authorized by Dell is not covered by your warranty. Read and follow the safety instructions that came with the product.

1. If installed, remove the front bezel.
2. Turn off the system, including any attached peripherals, and disconnect the system from the electrical outlet and peripherals.
3. Open the system.

**△ CAUTION:** The display module connector is a ZIF (zero insertion force) connector. Ensure that the locking tab on the connector is released before removal and insertion. The locking tab must be engaged after insertion.

4. Disconnect the USB cable, control panel cable, and the display module cable from the control-panel board.
5. Using a #2 Phillips screwdriver, remove the two screws that secure the control-panel board to the chassis.
6. Slide the control-panel board toward the back and lift it out of the system.

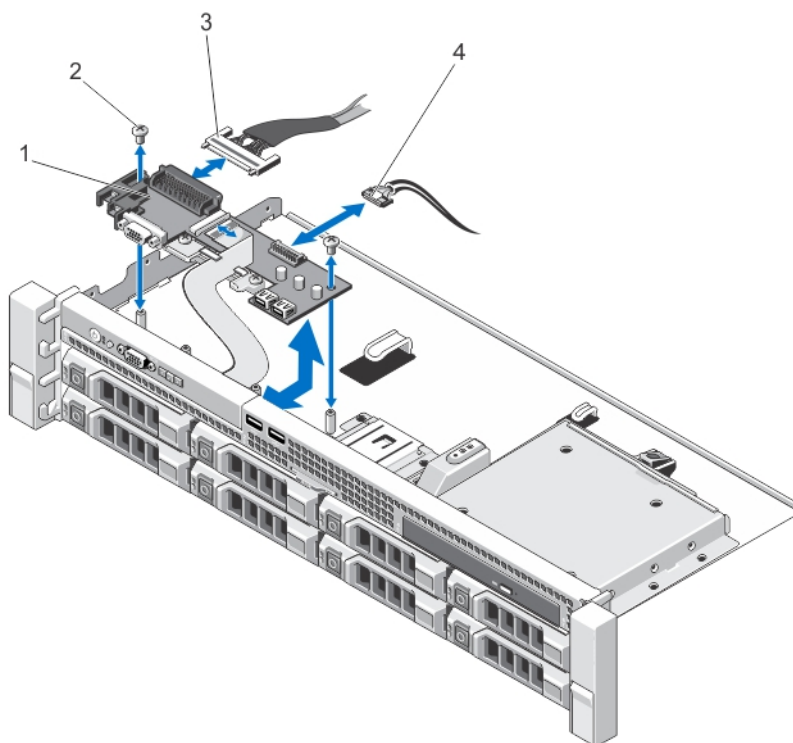

**Figure 54. Removing and Installing the Control-Panel Board**

1. control-panel board
2. screws (2)
3. control-panel data cable

4. USB cable

## Installing The Control-Panel Board

 **CAUTION:** Many repairs may only be done by a certified service technician. You should only perform troubleshooting and simple repairs as authorized in your product documentation, or as directed by the online or telephone service and support team. Damage due to servicing that is not authorized by Dell is not covered by your warranty. Read and follow the safety instructions that came with the product.

1. Align the screw holes on the control-panel board with the standoffs on the chassis.
2. Using a #2 Phillips screwdriver, replace the two screws that secure the control-panel board to the chassis.

 **CAUTION:** The display module connector is a ZIF (zero insertion force) connector. Ensure that the locking tab on the connector is released before removal and insertion. The locking tab must be engaged after insertion.

3. Connect the USB cable, control panel cable, and the display module cable to the control-panel board.
4. Route the power/data cables through the cable retention bracket.
5. Close the system.
6. If applicable, install the front bezel.
7. Reconnect the system to its electrical outlet and turn the system on, including any attached peripherals.

## Removing The Control Panel

 **CAUTION:** Many repairs may only be done by a certified service technician. You should only perform troubleshooting and simple repairs as authorized in your product documentation, or as directed by the online or telephone service and support team. Damage due to servicing that is not authorized by Dell is not covered by your warranty. Read and follow the safety instructions that came with the product.

1. If installed, remove the front bezel.
2. Turn off the system, including any attached peripherals, and disconnect the system from the electrical outlet and peripherals.
3. Open the system.

 **CAUTION:** The display module connector is a ZIF (zero insertion force) connector. Ensure that the locking tab on the connector is released before removal and insertion. The locking tab must be engaged after insertion.

4. Disconnect the display module cable from the control-panel board.

 **NOTE:** The control panel has six tabs that secure it to the chassis.

 **CAUTION:** Applying excessive force may damage the control panel.

5. Hold the top edge of the control panel at the corners and pull upward until the control panel tabs release.
6. Pull the control panel away from the chassis.

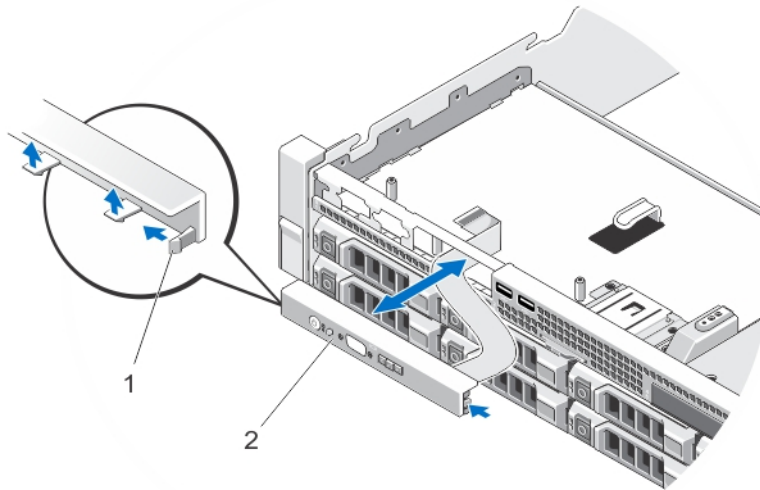

1. notches on chassis front wall (6)
2. control panel

## Installing The Control Panel

**⚠ CAUTION:** Many repairs may only be done by a certified service technician. You should only perform troubleshooting and simple repairs as authorized in your product documentation, or as directed by the online or telephone service and support team. Damage due to servicing that is not authorized by Dell is not covered by your warranty. Read and follow the safety instructions that came with the product.

1. Slide the left side of the control panel into the chassis so that the left tab on the control panel aligns with the slot on the chassis wall and the top left tab aligns with the slot on the top of the chassis.
2. Pull the display module cable through the opening and into the chassis.
3. Push the right side of the control panel until the top right tab aligns with the top of the chassis and the control panel snaps into place.

**⚠ CAUTION:** The display module connector is a ZIF (zero insertion force) connector. Ensure that the locking tab on the connector is released before removal and insertion. The locking tab must be engaged after insertion.

4. Connect the display module cable to the control panel board.
5. Close the system.
6. If applicable, install the front bezel.
7. Reconnect the system to its electrical outlet and turn the system on, including any attached peripherals.

## System Board

## Removing The System Board

**△ CAUTION:** Many repairs may only be done by a certified service technician. You should only perform troubleshooting and simple repairs as authorized in your product documentation, or as directed by the online or telephone service and support team. Damage due to servicing that is not authorized by Dell is not covered by your warranty. Read and follow the safety instructions that came with the product.

**△ CAUTION:** If you are using the Trusted Program Module (TPM) with an encryption key, you may be prompted to create a recovery key during program or System Setup. Be sure to create and safely store this recovery key. If you replace this system board, you must supply the recovery key when you restart your system or program before you can access the encrypted data on your hard drives.

1. Turn off the system, including any attached peripherals, and disconnect the system from the electrical outlet.
2. If installed, remove the front bezel.
3. Open the system.
4. Remove the following:
  - a) If installed, full length expansion card on slot 2 of expansion-card riser 2
  - b) cooling shroud
  - c) memory modules

**⚠ WARNING:** The memory modules are hot to touch for some time after the system has been powered down. Allow time for the memory modules to cool before handling them. Handle the memory modules by the card edges and avoid touching the components on the memory module.

- d) power supply(s)
- e) expansion cards
- f) integrated storage controller card
- g) expansion-card risers

**⚠ WARNING:** The heat sink is hot to touch for some time after the system has been powered down. Ensure that you do not touch the heat sink(s) while removing the system board.

- h) internal dual SD module

**△ CAUTION:** To avoid damaging the mini SAS cable and connector, follow the correct procedure when removing the mini SAS cable from the system board.

5. Disconnect the mini SAS cable from the system board:
  - a) Push the mini SAS cable connector to slide it further into the connector (SAS\_A) on the system board.
  - b) Press down and hold the metal tab on the mini SAS cable connector.
  - c) Pull the mini SAS cable out of the connector on the system board.

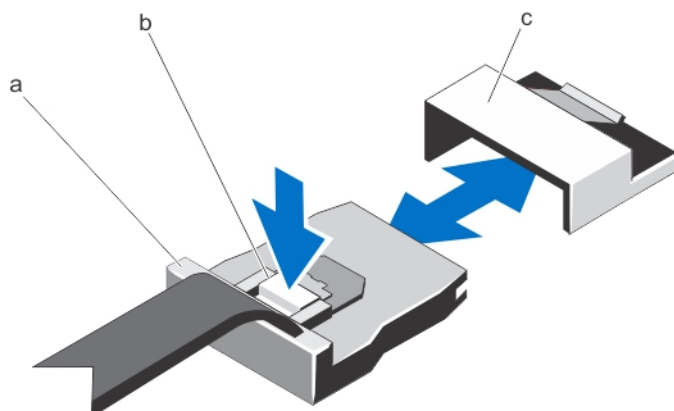

- a. mini SAS cable connector
  - b. metal tab
  - c. connector on the system board
6. Disconnect all other cables from the system board.

**CAUTION:** Take care not to damage the system identification button while removing the system board from the chassis.

7. Remove the system battery.
8. Grasp the system-board holder, slide the system board toward the front of the system, and lift the system board out of the chassis.

**CAUTION:** Do not lift the system board assembly by grasping a memory module, processor, or other components.

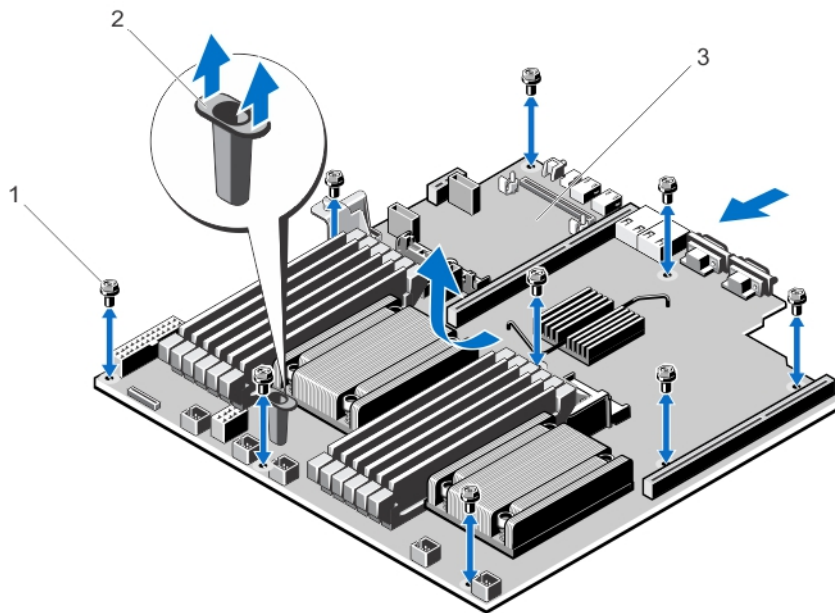

**Figure 55. Removing and Installing the System Board**

1. release screws (9)
2. system board holder
3. system board

## Installing The System Board

**CAUTION:** Many repairs may only be done by a certified service technician. You should only perform troubleshooting and simple repairs as authorized in your product documentation, or as directed by the online or telephone service and support team. Damage due to servicing that is not authorized by Dell is not covered by your warranty. Read and follow the safety instructions that came with the product.

1. Unpack the new system board assembly.

**CAUTION:** Do not lift the system board assembly by grasping a memory module, processor, or other components.

 **CAUTION: Take care not to damage the system identification button while placing the system board into the chassis.**

2. Holding the system board holder, lower the system board into the chassis.
3. Push the system board toward the back of the chassis until the board clicks into place.
4. Install the system battery.
5. Replace the following:
  - a) internal dual SD module
  - b) expansion cards and the integrated storage controller card
  - c) expansion-card risers
  - d) power supply(s)
  - e) memory modules
  - f) cooling shroud
  - g) If installed, full length expansion card on slot 2 of expansion-card riser 2
6. Connect the cables to the system board.
7. Route the power/data cables through the cable retention bracket.
8. Close the system.
9. If applicable, install the front bezel.
10. Reconnect the system to its electrical outlet and turn the system on, including any attached peripherals.
11. Import your new or existing iDRAC Ports license. For more information, see *iDRAC7 User's Guide*, at [dell.com/support/manuals](http://dell.com/support/manuals).



# Troubleshooting Your System

## Safety First—For You And Your System

 **CAUTION:** Many repairs may only be done by a certified service technician. You should only perform troubleshooting and simple repairs as authorized in your product documentation, or as directed by the online or telephone service and support team. Damage due to servicing that is not authorized by Dell is not covered by your warranty. Read and follow the safety instructions that came with the product.

## Troubleshooting System Startup Failure

If you boot the system to the BIOS boot mode after installing an operating system from the UEFI Boot Manager, the system hangs. The reverse is also true. You must boot to the same boot mode in which you installed the operating system.

For all other startup issues, note the system messages that appear on the screen.

## Troubleshooting External Connections

Ensure that all external cables are securely attached to the external connectors on your system before troubleshooting any external devices.

## Troubleshooting The Video Subsystem

1. Check the system and power connections to the monitor.
2. Check the video interface cabling from the system to the monitor.
3. Run the appropriate diagnostic test.

If the tests run successfully, the problem is not related to video hardware.

If the tests fail, see [Getting Help](#).

## Troubleshooting A USB Device

Use the following steps to troubleshoot a USB keyboard/mouse. For other USB devices, go to step 7.

1. Disconnect the keyboard and mouse cables from the system briefly and reconnect them.
2. Connect the keyboard/mouse to the USB port(s) on the opposite side of the system.
3. If the problem is resolved, restart the system, enter the System Setup, and check if the non-functioning USB ports are enabled.
4. Replace the keyboard/mouse with another working keyboard/mouse.
5. If the problem is resolved, replace the faulty keyboard/mouse.
6. If the problem is not resolved, proceed to the next step to begin troubleshooting the other USB devices attached to the system.

7. Power down all attached USB devices and disconnect them from the system.
8. Restart the system and, if your keyboard is functioning, enter the System Setup. Verify that all USB ports are enabled on the **Integrated Devices** screen, in the System Setup options.  
If your keyboard is not functioning, you can also use remote access. If the system is not accessible, reset the NVRAM\_CLR jumper inside your system and restore the BIOS to the default settings.
9. Reconnect and power on each USB device one at a time.
10. If a device causes the same problem, power down the device, replace the USB cable with a known good cable, and power up the device.

If all troubleshooting fails, see [Getting Help](#).

## Troubleshooting A Serial I/O Device

1. Turn off the system and any peripheral devices connected to the serial port.
2. Swap the serial interface cable with a working cable, and turn on the system and the serial device.  
If the problem is resolved, replace the interface cable with a known good cable.
3. Turn off the system and the serial device, and swap the device with a comparable device.
4. Turn on the system and the serial device.

If the problem persists, see [Getting Help](#).

## Troubleshooting A NIC

1. Run the appropriate diagnostic test. See Using System Diagnostics for available diagnostic tests.
2. Restart the system and check for any system messages pertaining to the NIC controller.
3. Check the appropriate indicator on the NIC connector:
  - If the link indicator does not light, check all cable connections.
  - If the activity indicator does not light, the network driver files might be damaged or missing. Remove and reinstall the drivers if applicable. See the NIC's documentation.
  - If applicable, change the autonegotiation setting.
  - Use another connector on the switch or hub.
4. Ensure that the appropriate drivers are installed and the protocols are bound. See the NIC's documentation.
5. Enter the System Setup and confirm that the NIC ports are enabled on the **Integrated Devices** screen.
6. Ensure that the NICs, hubs, and switches on the network are all set to the same data transmission speed and duplex. See the documentation for each network device.
7. Ensure that all network cables are of the proper type and do not exceed the maximum length.

If all troubleshooting fails, see [Getting Help](#).

## Troubleshooting A Wet System

 **CAUTION:** Many repairs may only be done by a certified service technician. You should only perform troubleshooting and simple repairs as authorized in your product documentation, or as directed by the online or telephone service and support team. Damage due to servicing that is not authorized by Dell is not covered by your warranty. Read and follow the safety instructions that came with the product.

1. Turn off the system and attached peripherals, and disconnect the system from the electrical outlet.
2. Open the system.
3. Disassemble components from the system:
  - Hard drives
  - Hard-drive backplane
  - USB memory key
  - Cooling shroud
  - Expansion-card risers (if present)
  - Expansion cards
  - Power supply(s)
  - Cooling-fan assembly (if present)
  - Cooling fans
  - Processor(s) and heat sink(s)
  - Memory modules
4. Let the system dry thoroughly for at least 24 hours.
5. Reinstall the components you removed in step 3.
6. Close the system.
7. Turn on the system and attached peripherals.  
If the system does not start properly, see [Getting Help](#).
8. If the system starts properly, shut down the system and reinstall all of the expansion cards that you removed.
9. Run the appropriate diagnostic test. For more information, see Using System Diagnostics.

If the tests fail, see [Getting Help](#).

## Troubleshooting A Damaged System

 **CAUTION:** Many repairs may only be done by a certified service technician. You should only perform troubleshooting and simple repairs as authorized in your product documentation, or as directed by the online or telephone service and support team. Damage due to servicing that is not authorized by Dell is not covered by your warranty. Read and follow the safety instructions that came with the product.

1. Turn off the system and attached peripherals, and disconnect the system from the electrical outlet.
2. Open the system.
3. Ensure that the following components are properly installed:
  - Cooling shroud
  - Expansion-card risers (if present)
  - Expansion cards
  - Power supply(s)

- Cooling-fan assembly (if present)
  - Cooling fans
  - Processor(s) and heat sink(s)
  - Memory modules
  - Hard-drive carriers
  - Hard-drive backplane
4. Ensure that all cables are properly connected.
  5. Close the system.
  6. Run the appropriate diagnostic test. For more information, see [Using System Diagnostics](#).

If the tests fail, see [Getting Help](#).

## Troubleshooting The System Battery

 **CAUTION:** Many repairs may only be done by a certified service technician. You should only perform troubleshooting and simple repairs as authorized in your product documentation, or as directed by the online or telephone service and support team. Damage due to servicing that is not authorized by Dell is not covered by your warranty. Read and follow the safety instructions that came with the product.

 **NOTE:** If the system is turned off for long periods of time (for weeks or months), the NVRAM may lose its system configuration information. This situation is caused by a defective battery.

1. Re-enter the time and date in the System Setup.
2. Turn off the system and disconnect it from the electrical outlet for at least one hour.
3. Reconnect the system to the electrical outlet and turn on the system.
4. Enter the System Setup.  
If the date and time are not correct in the System Setup, check the SEL for system battery messages.

If the problem is not resolved, see [Getting Help](#).

 **NOTE:** Some software may cause the system time to speed up or slow down. If the system seems to operate normally except for the time kept in the System Setup, the problem may be caused by software rather than by a defective battery.

## Troubleshooting Power Supplies

 **CAUTION:** Many repairs may only be done by a certified service technician. You should only perform troubleshooting and simple repairs as authorized in your product documentation, or as directed by the online or telephone service and support team. Damage due to servicing that is not authorized by Dell is not covered by your warranty. Read and follow the safety instructions that came with the product.

1. Reseat the power supply by removing and reinstalling it.  
 **NOTE:** After installing a power supply, allow several seconds for the system to recognize the power supply and to determine if it is working properly.
2. If the problem persists, see [Getting Help](#).

## Troubleshooting Cooling Problems

 **CAUTION:** Many repairs may only be done by a certified service technician. You should only perform troubleshooting and simple repairs as authorized in your product documentation, or as directed by the online or telephone service and support team. Damage due to servicing that is not authorized by Dell is not covered by your warranty. Read and follow the safety instructions that came with the product.

Ensure that none of the following conditions exist:

- System cover, cooling shroud, EMI filler panel, memory-module blank, or back-filler bracket is removed.
- Ambient temperature is too high.
- External airflow is obstructed.
- A cooling fan is removed or has failed.
- The expansion card installation guidelines have not been followed.

## Troubleshooting Cooling Fans

 **CAUTION:** Many repairs may only be done by a certified service technician. You should only perform troubleshooting and simple repairs as authorized in your product documentation, or as directed by the online or telephone service and support team. Damage due to servicing that is not authorized by Dell is not covered by your warranty. Read and follow the safety instructions that came with the product.

1. Open the system.
2. Reseat the fan or the fan's power cable.
3. If the fan functions properly, close the system.

If the problem persists, see [Getting Help](#).

## Troubleshooting System Memory

 **CAUTION:** Many repairs may only be done by a certified service technician. You should only perform troubleshooting and simple repairs as authorized in your product documentation, or as directed by the online or telephone service and support team. Damage due to servicing that is not authorized by Dell is not covered by your warranty. Read and follow the safety instructions that came with the product.

1. If the system is operational, run the appropriate diagnostic test. See Using System Diagnostics for available diagnostic tests.  
If diagnostics indicates a fault, follow the corrective actions provided by the diagnostic program.
2. If the system is not operational, turn off the system and attached peripherals, and unplug the system from the power source. Wait at least 10 seconds and then reconnect the system to power.
3. Turn on the system and attached peripherals and note the messages on the screen.  
If an error message is displayed indicating a fault with a specific memory module, go to step 12.
4. Enter the System Setup and check the system memory setting. Make any changes to the memory settings, if needed.  
If the memory settings match the installed memory but a problem is still indicated, go to step 12.
5. Turn off the system and attached peripherals, and disconnect the system from the electrical outlet.
6. Open the system.
7. Check the memory channels and ensure that they are populated correctly.

8. Reseat the memory modules in their sockets.
9. Close the system.
10. Enter the System Setup and check the system memory setting.  
If the problem is not resolved, proceed with the next step.
11. Open the system.
12. If a diagnostic test or error message indicates a specific memory module as faulty, swap or replace the module with a known good memory module.
13. To troubleshoot an unspecified faulty memory module, replace the memory module in the first DIMM socket with a module of the same type and capacity.  
If an error message is displayed on the screen, this may indicate a problem with the installed DIMM type(s), incorrect DIMM installation, or defective DIMM(s). Follow the on-screen instructions to resolve the problem. For more information, see General Memory Module Installation Guidelines.
14. Close the system.
15. As the system boots, observe any error message that is displayed and the diagnostic indicators on the front of the system.
16. If the memory problem is still indicated, repeat step 12 through step 15 for each memory module installed.

If the problem persists after all memory modules have been checked, see [Getting Help](#).

## Troubleshooting An Internal USB Key

 **CAUTION:** Many repairs may only be done by a certified service technician. You should only perform troubleshooting and simple repairs as authorized in your product documentation, or as directed by the online or telephone service and support team. Damage due to servicing that is not authorized by Dell is not covered by your warranty. Read and follow the safety instructions that came with the product.

1. Enter the System Setup and ensure that the **USB key port** is enabled from the **Integrated Devices** screen.
2. Turn off the system and attached peripherals, and disconnect the system from the electrical outlet.
3. Open the system.
4. Locate the USB key and reseat it.
5. Close the system.
6. Turn on the system and attached peripherals and check if the USB key is functioning.
7. If the problem is not resolved, repeat step 2 and step 3.
8. Insert a different USB key that you know works properly.
9. Close the system.

If the problem is not resolved, see [Getting Help](#).

## Troubleshooting An SD Card

 **CAUTION:** Many repairs may only be done by a certified service technician. You should only perform troubleshooting and simple repairs as authorized in your product documentation, or as directed by the online or telephone service and support team. Damage due to servicing that is not authorized by Dell is not covered by your warranty. Read and follow the safety instructions that came with the product.

 **NOTE:** Certain SD cards have a physical write-protect switch on the card. If the write-protect switch is turned on then the SD card is not writeable.

1. Enter the System Setup and ensure that the **Internal SD Card Port** is enabled.
2. Turn off the system, including any attached peripherals, and disconnect the system from the electrical outlet.
3. Open the system.

 **CAUTION:** If the **Internal SD Card Redundancy** option is set to **Mirror Mode** in the **Integrated Devices** screen of the **System Setup**, you must follow the instructions in **step 4** through **step 7** to avoid loss of data.

 **NOTE:** When an SD card failure occurs, the internal dual SD module controller notifies the system. On the next reboot, the system displays a message indicating the failure.

4. If the **Internal SD Card Redundancy** option is set to **Disabled**, replace the failed SD card with a new SD card.
5. If SD card 1 has failed, remove the card from SD card slot 1. If SD card 2 has failed, install a new SD card in SD card slot 2 and proceed to step 7.
6. Remove the card present in SD card slot 2 and insert it into SD card slot 1.
7. Insert the new SD card into SD card slot 2.
8. Close the system.
9. Reconnect the system to its electrical outlet and turn the system on, including any attached peripherals.
10. Enter the System Setup and ensure that the **Internal SD Card Port** and **Internal SD Card Redundancy** mode is enabled.
11. Check if the SD card is functioning properly.  
If the problem persists, see [Getting Help](#).

## Troubleshooting An Optical Drive

 **CAUTION:** Many repairs may only be done by a certified service technician. You should only perform troubleshooting and simple repairs as authorized in your product documentation, or as directed by the online or telephone service and support team. Damage due to servicing that is not authorized by Dell is not covered by your warranty. Read and follow the safety instructions that came with the product.

1. Try using a different CD or DVD.
2. Enter the System Setup and ensure that the integrated SATA controller and the drive's SATA port are enabled.
3. Run the appropriate diagnostic test.
4. Turn off the system and attached peripherals, and disconnect the system from the electrical outlet.
5. Open the system.
6. Remove the front bezel.
7. Ensure that the interface cable is securely connected to the optical drive and to the controller.
8. Ensure that a power cable is properly connected to the drive.
9. Close the system.

If the problem is not resolved, see [Getting Help](#).

## Troubleshooting A Hard Drive

 **CAUTION:** Many repairs may only be done by a certified service technician. You should only perform troubleshooting and simple repairs as authorized in your product documentation, or as directed by the online or telephone service and support team. Damage due to servicing that is not authorized by Dell is not covered by your warranty. Read and follow the safety instructions that came with the product.

 **CAUTION:** This troubleshooting procedure can erase data stored on the hard drive. Before you proceed, back up all files on the hard drive.

1. Run the appropriate diagnostic test. For more information, see Using System Diagnostics.  
Depending on the results of the diagnostics test, proceed as needed through the following steps.
2. If your system has a RAID controller and your hard drives are configured in a RAID array, perform the following steps:
  - a) Restart the system and press <F10> during system startup to run the Lifecycle Controller, and then run the Hardware Configuration wizard to check the RAID configuration.  
See the Lifecycle Controller documentation or online help for information on RAID configuration.
  - b) Ensure that the hard drive(s) have been configured correctly for the RAID array.
  - c) Take the hard drive offline and reseal the drive.
  - d) Exit the configuration utility and allow the system to boot to the operating system.
3. Ensure that the required device drivers for your controller card are installed and are configured correctly. See the operating system documentation for more information.
4. Restart the system and enter the System Setup.
5. Verify that the controller is enabled and the drives are displayed in the System Setup.

If the problem persists, try troubleshooting the expansion cards or see [Getting Help](#).

## Troubleshooting A Storage Controller

 **CAUTION:** Many repairs may only be done by a certified service technician. You should only perform troubleshooting and simple repairs as authorized in your product documentation, or as directed by the online or telephone service and support team. Damage due to servicing that is not authorized by Dell is not covered by your warranty. Read and follow the safety instructions that came with the product.

 **NOTE:** When troubleshooting a SAS or PERC controller, also see the documentation for your operating system and the controller.

1. Run the appropriate diagnostic test. For more information, see Using System Diagnostics.
2. Turn off the system and attached peripherals, and disconnect the system from the electrical outlet.
3. Open the system.
4. Verify that the installed expansion cards are compliant with the expansion card installation guidelines.
5. Ensure that each expansion card is firmly seated in its connector.
6. Close the system
7. Reconnect the system to the electrical outlet, and turn on the system and attached peripherals.
8. If the problem is not resolved, turn off the system and attached peripherals, and disconnect the system from the electrical outlet.
9. Open the system.
10. Remove all expansion cards installed in the system.



11. Close the system.
12. Reconnect the system to the electrical outlet, and turn on the system and attached peripherals.
13. Run the appropriate diagnostic test. For more information, see Using System Diagnostics. If the tests fail, see [Getting Help](#).
14. For each expansion card you removed in step 10, perform the following steps:
  - a. Turn off the system and attached peripherals, and disconnect the system from the electrical outlet.
  - b. Open the system.
  - c. Reinstall one of the expansion cards.
  - d. Close the system.
  - e. Run the appropriate diagnostic test. For more information, see Using System Diagnostics.

If the tests fail, see [Getting Help](#).

## Troubleshooting Expansion Cards

 **CAUTION:** Many repairs may only be done by a certified service technician. You should only perform troubleshooting and simple repairs as authorized in your product documentation, or as directed by the online or telephone service and support team. Damage due to servicing that is not authorized by Dell is not covered by your warranty. Read and follow the safety instructions that came with the product.

 **NOTE:** When troubleshooting an expansion card, see the documentation for your operating system and the expansion card.

1. Run the appropriate diagnostic test. For more information, see Using System Diagnostics.
2. Turn off the system and attached peripherals, and disconnect the system from the electrical outlet.
3. Open the system.
4. Ensure that each expansion card is firmly seated in its connector.
5. Close the system.
6. If the problem is not resolved, turn off the system and attached peripherals, and disconnect the system from the electrical outlet.
7. Open the system.
8. Remove all expansion cards installed in the system.
9. Close the system.
10. Run the appropriate diagnostic test. For more information, see Using System Diagnostics.  
If the tests fail, see [Getting Help](#).
11. For each expansion card you removed in step 8, perform the following steps:
  - a) Turn off the system and attached peripherals, and disconnect the system from the electrical outlet.
  - b) Open the system.
  - c) Reinstall one of the expansion cards.
  - d) Close the system.
  - e) Run the appropriate diagnostic test. For more information, see Using System Diagnostics.

If a problem is still indicated, see [Getting Help](#).

## Troubleshooting Processors

 **CAUTION:** Many repairs may only be done by a certified service technician. You should only perform troubleshooting and simple repairs as authorized in your product documentation, or as directed by the online or telephone service and support team. Damage due to servicing that is not authorized by Dell is not covered by your warranty. Read and follow the safety instructions that came with the product.

1. Run the appropriate diagnostics test. See Using System Diagnostics for available diagnostic tests.
2. Turn off the system and attached peripherals, and disconnect the system from the electrical outlet.
3. Open the system.
4. Ensure that the processor and heat sink are properly installed.
5. Close the system.
6. Run the appropriate diagnostic test. For more information , see Using System Diagnostics.

If a problem is still indicated, see [Getting Help](#).

# Using System Diagnostics

If you experience a problem with your system, run the system diagnostics before contacting Dell for technical assistance. The purpose of running system diagnostics is to test your system hardware without requiring additional equipment or risking data loss. If you are unable to fix the problem yourself, service and support personnel can use the diagnostics results to help you solve the problem.

## Dell Online Diagnostics

Dell Online Diagnostics, a stand-alone suite of diagnostic programs or test modules, allows you to run diagnostic tests on the systems in a production environment, and helps you ensure maximum uptime of your systems. Online Diagnostics allows you to run diagnostic tests on chassis and storage components such as hard drives, physical memory, and network interface cards (NICs). You can use the graphical user interface (GUI) or the command line interface (CLI) to run diagnostic tests on the hardware that Online Diagnostics discovers on your system. For information about using diagnostics, see the *Dell Online PowerEdge Diagnostics User's Guide* under **Software** → **Serviceability Tools**, at [dell.com/support/manuals](http://dell.com/support/manuals).

## Dell Embedded System Diagnostics

 **NOTE:** Also known as Enhanced Pre-boot System Assessment (ePSA) diagnostics.

The embedded system diagnostics provides a set of options for particular device groups or devices allowing you to:

- Run tests automatically or in an interactive mode
- Repeat tests
- Display or save test results
- Run thorough tests to introduce additional test options to provide extra information about the failed device(s)
- View status messages that inform you if tests are completed successfully
- View error messages that inform you of problems encountered during testing

## When To Use The Embedded System Diagnostics

If a major component or device in the system does not operate properly, running the embedded system diagnostics may indicate component failure.

## Running The Embedded System Diagnostics

The embedded system diagnostics program is run from the Dell Lifecycle Controller.

 **CAUTION:** Use the embedded system diagnostics to test only your system. Using this program with other systems may cause invalid results or error messages.

1. As the system boots, press <F11>.
2. Use the up and down arrow keys to select **System Utilities** → **Launch Dell Diagnostics** .

The **ePSA Pre-boot System Assessment** window is displayed, listing all devices detected in the system. The diagnostics starts executing the tests on all the detected devices.

## System Diagnostic Controls

<b>Menu</b>	<b>Description</b>
<b>Configuration</b>	Displays the configuration and status information of all detected devices.
<b>Results</b>	Displays the results of all tests that are executed.
<b>System Health</b>	Provides the current overview of the system performance.
<b>Event Log</b>	Displays a time-stamped log of the results of all tests run on the system. This is displayed if at least one event description is recorded.





For information about embedded system diagnostics, see the *Dell Enhanced Pre-boot System Assessment User Guide* at [dell.com/support/manuals](http://dell.com/support/manuals).

# Jumpers And Connectors

## System Board Jumper Settings

For information on resetting the password jumper to disable a password, see [Disabling A Forgotten Password](#).

**Table 5. System Board Jumper Settings**

Jumper	Setting	Description
PWRD_EN	 2 4 6 (default)	The password feature is enabled (pins 2–4).
	 2 4 6	The password feature is disabled (pins 4–6). iDRAC local access is unlocked at the next AC power cycle.
NVRAM_CLR	 1 3 5 (default)	The configuration settings are retained at system boot (pins 3–5).
	 1 3 5	The configuration settings are cleared at the next system boot (pins 1–3).

# System Board Connectors

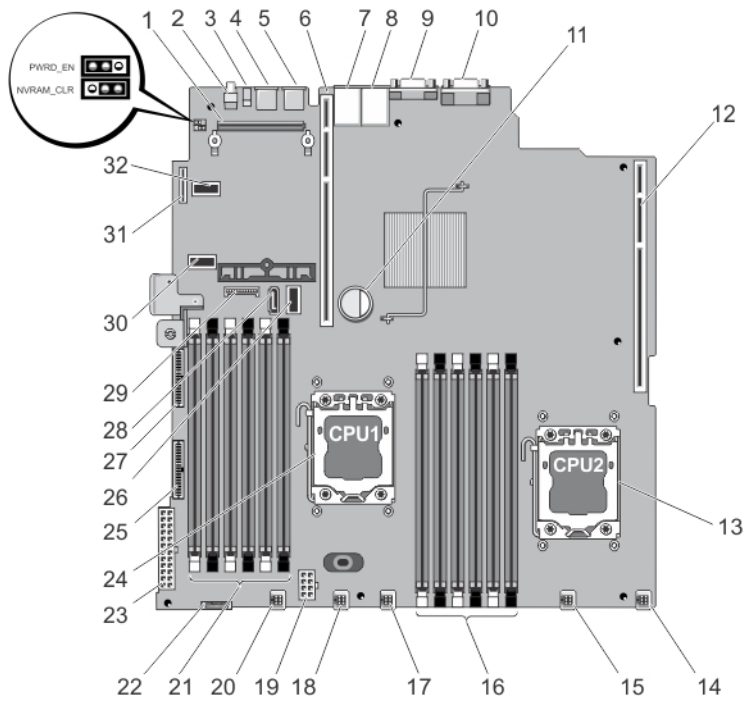

Figure 56. System Board Connectors and Jumpers

Item	Connector	Description
1	INT_STORAGE	Storage controller card connector
2	ID_BTN	System identification button
3	CMA_JACK	System identification connector
4	USB 2	USB connector
5	USB 1	USB connector
6	IO_RISER2	Riser 2 connector
7	NIC2	Network connector
8	NIC1	Network connector
9	VGA	Video connector
10	COM	Serial connector
11	BATTERY	Battery connector
12	IO_RISER1	Riser 1 connector
13	CPU2	Processor socket 2
14	FAN6	Cooling fan connector

Item	Connector	Description
15	FAN5	Cooling fan connector
16	B1, B4, B2, B5, B3, B6	Memory module sockets
17	FAN4	Cooling fan connector
18	FAN3	Cooling fan connector
19	PWR_CONN_1	8-pin power connector
20	FAN2	Cooling fan connector
21	A1, A4, A2, A5, A3, A6	Memory module sockets
22	BP_SIG	Backplane signal connector
23	PWR_CONN_2	24-pin power connector
24	CPU1	Processor socket 1
25	PDB_CONN	Power distribution board connector
26	SATA_A-D	SATA connector A to D
27	CTRL_PNL_MB	Control panel interface connector
28	SATA_E	Optical drive SATA connector
29	FP_USB	Front panel USB connector
30	SAS_A	Mini-SAS connector
31	IDSDM	Internal Dual SD Module
32	SAS_B	Mini-SAS connector

## Disabling A Forgotten Password

The system's software security features include a system password and a setup password. The password jumper enables these password features or disables them and clears any password(s) currently in use.



**CAUTION:** Many repairs may only be done by a certified service technician. You should only perform troubleshooting and simple repairs as authorized in your product documentation, or as directed by the online or telephone service and support team. Damage due to servicing that is not authorized by Dell is not covered by your warranty. Read and follow the safety instructions that came with the product.

1. Turn off the system, including any attached peripherals, and disconnect the system from the electrical outlet.
2. Open the system.
3. Move the jumper on the system-board jumper from pins 4 and 6 to pins 2 and 4.
4. Close the system.

The existing passwords are not disabled (erased) until the system boots with the Jumper on pins 2 and 4. However, before you assign a new system and/or setup password, you must move the jumper back to pins 4 and 6.



**NOTE:** If you assign a new system and/or setup password with the jumper on pins 2 and 4, the system disables the new password(s) the next time it boots.



5. Reconnect the system to its electrical outlet and turn the system on, including any attached peripherals.
6. Turn off the system, including any attached peripherals, and disconnect the system from the electrical outlet.

7. Open the system.
8. Move the jumper on the system-board jumper from pins 2 and 4 to pins 4 and 6.
9. Close the system.
10. Reconnect the system to its electrical outlet and turn the system on, including any attached peripherals.
11. Assign a new system and/or setup password.



# Technical Specifications

<b>Processor</b>	
Processor type	One or two Intel Xeon processor E5-2400 and E5-2400 v2 product family
<b>Expansion Bus</b>	
Bus type	PCI Express Generation 2 and Generation 3
<b>Expansion slots using riser card for a one processor system:</b>	
Riser 1	(Slot 1) One half-height, half-length x4 link with x8 slot
Riser 2	(Slot 2) One full-height, full-length x8 link with x16 slot (Slot 3) One full-height, half-length x4 link with x8 slot (Slot 4) One full-height, half-length x4 link with x8 slot
<b>Expansion slots using riser card for a two processor system:</b>	
Riser 1	(Slot 1) One half-height, half-length x16 link with x16 slot
Riser 2	(Slot 2) One full-height, full-length x8 link with x16 slot (Slot 3) One full-height, half-length x8 link with x16 slot (Slot 4) One full-height, half-length x8 link with x16 slot
	 <b>NOTE:</b> If you install a second processor, you must:
	<ul style="list-style-type: none"> <li>• remove the dummy fan from the FAN6 slot</li> <li>• install a cooling fan in the FAN6 slot</li> <li>• upgrade both the expansion-card risers (riser 1 and riser 2)</li> </ul>
<b>Memory</b>	
Architecture	1600 MT/s, 1333 MT/s, or 1066 MT/s DDR3 and LV-DDR3 DIMMs
Memory module sockets	Twelve 240-pin
Memory module capacities	
RDIMMs	2 GB (single-rank), 4 GB (single- and dual-rank), 8 GB (dual-rank), 16 GB (dual-rank), and 32 GB (quad-rank)
UDIMMs	2 GB (single-rank) and 4 GB (dual-rank)

<b>Memory</b>	
Minimum RAM	2 GB (single processor configuration)
Maximum RAM	384 GB
<b>Drives</b>	
Hard drives	<p>Up to eight 3.5 inch or 2.5 inch, internal, hot-swappable SAS, SATA, SAS SSD, SATA SSD, or Nearline SAS hard drives in hard-drive slots 0 through 7.</p> <p>Up to four 3.5 inch or 2.5 inch, internal, hot-swappable SAS, SATA, SAS SSD, SATA SSD, or Nearline SAS hard drives in hard-drive slots 0 through 3 for a software RAID system.</p>
Optical drive	<p>One optional slimline SATA DVD-ROM or DVD+/-RW drive</p> <p> <b>NOTE:</b> DVD devices are data only.</p>
<b>Connectors</b>	
<b>Back</b>	
NIC	Two RJ-45 10/100/1000 Mbps
Serial	9-pin, DTE, 16550-compatible
USB	Two 4-pin, USB 2.0-compliant
Video	15-pin VGA
iDRAC7 (Optional)	One 1GbE Ethernet port
External vFlash card (Optional)	<p>vFlash memory card</p> <p> <b>NOTE:</b> The card slot is available for use only if the iDRAC7 Enterprise license is installed on your system.</p>
<b>Front</b>	
USB	Two 4-pin, USB 2.0-compliant
Video	15-pin VGA
<b>Internal</b>	
USB	One 4-pin, USB 2.0-compliant
Internal Dual SD Module (IDSDM)	<p>Two optional flash memory card slots with the internal SD module</p> <p> <b>NOTE:</b> One card slot is dedicated for redundancy.</p>

<b>Video</b>	
<b>Video type</b>	<b>Integrated Matrox G200</b>
<b>Video memory</b>	<b>16 MB shared</b>

---

### Expanded Operating Temperature

---

 **NOTE:** When operating in the expanded temperature range, system performance may be impacted.

 **NOTE:** When operating in the expanded temperature range, ambient temperature warnings may be reported on the LCD and in the System Event Log.

≤ 10% of annual operating hours

5 °C to 40 °C at 5% to 85% RH with 26 °C dew point.

 **NOTE:** Outside the standard operating temperature (10 °C to 35 °C), the system can operate down to 5 °C or up to 40 °C for a maximum of 10% of its annual operating hours.

For temperatures between 35 °C and 40 °C, de-rate maximum allowable dry bulb temperature by 1 °C per 175 m above 950 m (1 °F per 319 ft).

≤ 1% of annual operating hours

–5 °C to 45 °C at 5% to 90% RH with 26 °C dew point.

 **NOTE:** Outside the standard operating temperature (10 °C to 35 °C), the system can operate down to –5 °C or up to 45 °C for a maximum of 1% of its annual operating hours.

For temperatures between 40 °C and 45 °C, de-rate maximum allowable dry bulb temperature by 1 °C per 125 m above 950 m (1 °F per 228 ft).

Expanded Operating Temperature Restrictions

- Do not perform a cold startup below 5 °C.
- Allow processor performance degrade.
- Non-redundant power supplies are not supported.
- Non Dell qualified peripheral cards and/or peripheral cards greater than 25 W are not supported.
- Maximum altitude for the operating temperature must be 3050 m (10,000 ft).

---

### Environmental

---

 **NOTE:** For additional information about environmental measurements for specific system configurations, see [dell.com/environmental\\_datasheets](http://dell.com/environmental_datasheets).

#### Temperature

Maximum Temperature Gradient (Operating and Storage) 20 °C/h (36 °F/h)

Storage Temperature Limits –40 °C to 65 °C (–40 °F to 149 °F)

#### Temperature (Continuous Operation)

---

**Environmental**

---

Temperature Ranges (for altitude less than 950 m or 3117 ft) 10 °C to 35 °C (50 °F to 95 °F) with no direct sunlight on the equipment.

Humidity Percentage Range 10% to 80% Relative Humidity with 26 °C (78.8 °F) maximum dew point.

**Relative Humidity**

Storage 5% to 95% RH with 33 °C (91 °F) maximum dew point. Atmosphere must be non-condensing at all times.

**Maximum Vibration**

Operating 0.26 G<sub>rms</sub> at 5 Hz to 350 Hz (all operation orientations).

Storage 1.87 G<sub>rms</sub> at 10 Hz to 500 Hz for 15 min (all six sides tested).

**Maximum Shock**

Operating One shock pulse in the positive z axis of 31 G for 2.6 ms in all operational orientations.

Storage Six consecutively executed shock pulses in the positive and negative x, y, and z axes (one pulse on each side of the system) of 71 G for up to 2 ms.

**Maximum Altitude**

Operating 3048 m (10,000 ft).

Storage 12,000 m (39,370 ft).

**Operating Altitude De-rating**

Up to 35 °C (95 °F) Maximum temperature is reduced by 1 °C/300 m (1 °F/547 ft) above 950 m (3,117 ft).

35 °C to 40 °C (95 °F to 104 °F) Maximum temperature is reduced by 1 °C/175 m (1 °F/319 ft) above 950 m (3,117 ft).

40 °C to 45 °C (104 °F to 113 °F) Maximum temperature is reduced by 1 °C/125 m (1 °F/228 ft) above 950 m (3,117 ft).

**Particulate Contamination**

 **NOTE:** This section defines the limits to help avoid IT equipment damage and/or failure from particulates and gaseous contamination. If it is determined that levels of particulates or gaseous pollution are beyond the limits specified below and are the reason for the damage and/or failures to your equipment, it may be necessary for you to re-mediate the environmental conditions that are causing the damage and/or failures. Re-mediation of environmental conditions will be the responsibility of the customer.

**Air Filtration**

Data center air filtration as defined by ISO Class 8 per ISO 14644-1 with a 95% upper confidence limit.

 **NOTE:** Applies to data center environments only. Air filtration requirements do not apply to IT equipment designed to be used outside a data center, in environments such as an office or factory floor.

 **NOTE:** Air entering the data center must have MERV11 or MERV13 filtration.

---

**Environmental**

---

Conductive Dust

Air must be free of conductive dust, zinc whiskers, or other conductive particles.

 **NOTE:** Applies to data center and non-data center environments.

Corrosive Dust

- Air must be free of corrosive dust.
- Residual dust present in the air must have a deliquescent point less than 60% relative humidity.

 **NOTE:** Applies to data center and non-data center environments.

**Gaseous Contamination**

 **NOTE:** Maximum corrosive contaminant levels measured at  $\leq 50\%$  relative humidity.

Copper Coupon Corrosion Rate

$<300 \text{ \AA/month}$  per Class G1 as defined by ANSI/ISA71.04-1985.

Silver Coupon Corrosion Rate

$<200 \text{ \AA/month}$  as defined by AHSRAE TC9.9.



# System Messages

## LCD Messages

 **NOTE:** Applicable only if your system has an LCD display.

The LCD messages consist of brief text messages that refer to events recorded in the System Event Log (SEL). For information on the SEL and configuring system management settings, see the systems management software documentation.

 **NOTE:** If your system fails to boot, press the System ID button for at least 5 seconds until an error code is displayed on the LCD. Record the code, then see System Error Messages.

## Viewing LCD Messages

If a system error occurs, the LCD screen will turn amber. Press the Select button to view the list of errors or status messages. Use the Left and Right buttons to highlight an error number, and press the Select button to view the error.

## Removing LCD Messages

For faults associated with sensors, such as temperature, voltage, fans, and so on, the LCD message is automatically removed when that sensor returns to a normal state. For other faults, you must take action to remove the message from the display:

- Clear the SEL — You can perform this task remotely, but you will lose the event history for the system.
- Power cycle — Turn off the system and disconnect it from the electrical outlet; wait approximately 10 seconds, reconnect the power cable, and restart the system.

## System Error Messages

System messages appear on the monitor to notify you of a possible problem with the system. These messages refer to events recorded in the System Event Log (SEL). For information on the SEL and configuring system management settings, see the systems management software documentation.

Some messages are also displayed in an abbreviated form on the system's LCD, if the system includes that feature.

 **NOTE:** The LCD error messages listed here are displayed in the simple format. See Setup Menu to select the format in which the messages are displayed.

 **NOTE:** If you receive a system message not listed here, check the documentation of the application that was running when the message was displayed or the operating system's documentation for an explanation of the message and recommended action.

 **NOTE:** In some messages, a particular system component is identified by name ("`<name>`") component number ("`<number>`"), or location ("`bay`").

Error Code	Message Information	
AMP0302	<b>Message</b>	The system board <name> current is greater than the upper warning threshold.
	<b>Details</b>	System board <name> current is outside of the optimum range.
	<b>Action</b>	<ol style="list-style-type: none"> <li>1. Review system power policy.</li> <li>2. Check system logs for power related failures.</li> <li>3. Review system configuration changes.</li> <li>4. If the issue persists, see <a href="#">Getting Help</a>.</li> </ol>
AMP0303	<b>Message</b>	The system board <name> current is greater than the upper critical threshold.
	<b>LCD Message</b>	System board <name> current is outside of range.
	<b>Details</b>	System board <name> current is outside of the optimum range.
	<b>Action</b>	<ol style="list-style-type: none"> <li>1. Review system power policy.</li> <li>2. Check system logs for power related failures.</li> <li>3. Review system configuration changes.</li> <li>4. If the issue persists, see <a href="#">Getting Help</a>.</li> </ol>
ASR0000	<b>Message</b>	The watchdog timer expired.
	<b>Details</b>	The operating system or an application failed to communicate within the time-out period.
	<b>Action</b>	Check the operating system, application, hardware, and system event log for exception events.
ASR0001	<b>Message</b>	The watchdog timer reset the system.
	<b>Details</b>	The operating system or an application failed to communicate within the time-out period. The system was reset.
	<b>Action</b>	Check the operating system, application, hardware, and system event log for exception events.
ASR0002	<b>Message</b>	The watchdog timer powered off the system.
	<b>Details</b>	The operating system or an application failed to communicate within the time-out period. The system was shut down.
	<b>Action</b>	Check the operating system, application, hardware, and system event log for exception events.



<b>Error Code</b>	<b>Message Information</b>	
<b>ASR0003</b>	<b>Message</b>	The watchdog timer power cycled the system.
	<b>Details</b>	The operating system or an application failed to communicate within the time-out period. The system was power-cycled.
	<b>Action</b>	Check the operating system, application, hardware, and system event log for exception events.
<b>BAT0002</b>	<b>Message</b>	The system board battery has failed.
	<b>LCD Message</b>	The system board battery has failed. Check battery.
	<b>Details</b>	The system board battery is either missing or bad.
	<b>Action</b>	See <a href="#">Getting Help</a> .
<b>BAT0017</b>	<b>Message</b>	The <name> battery has failed.
	<b>LCD Message</b>	The <name> battery has failed. Check battery.
	<b>Details</b>	The <name> battery is either missing, bad, or unable to charge due to thermal issues.
	<b>Action</b>	Check system fans. If the problem persists, see <a href="#">Getting Help</a> .
<b>CPU0000</b>	<b>Message</b>	CPU <number> has an internal error (IERR).
	<b>LCD Message</b>	CPU <number> has an internal error (IERR).
	<b>Details</b>	System Event Log and Operating System Logs may indicate that the exception is external to the processor.
	<b>Action</b>	Review System Event Log and Operating System Logs. If the issue persists, see <a href="#">Getting Help</a> .
<b>CPU0001</b>	<b>Message</b>	CPU <number> has a thermal trip (over-temperature) event.
	<b>LCD Message</b>	CPU <number> has a thermal trip. Check CPU heat sink.
	<b>Details</b>	The processor temperature increased beyond the operational range.
	<b>Action</b>	Review the logs for fan failures. If no fan failures are detected, check inlet temperature (if available) and reinstall processor heat sink. If the problem persists, see <a href="#">Getting Help</a> .
<b>CPU0005</b>	<b>Message</b>	CPU <number> configuration is unsupported.
	<b>LCD Message</b>	CPU <number> configuration is unsupported. Check CPU or BIOS revision.
	<b>Details</b>	System is unable to boot or may run in a degraded state.

Error Code	Message Information	
	<b>Action</b>	Review the technical specifications for supported processor types.
CPU0010	<b>Message</b>	CPU <number> is throttled.
	<b>Details</b>	The CPU is throttled due to thermal or power conditions.
	<b>Action</b>	Review system logs for power or thermal exceptions.
CPU0023	<b>Message</b>	CPU <number> is absent.
	<b>LCD Message</b>	CPU <number> is absent. Check CPU.
	<b>Action</b>	Verify processor installation. If present, re-seat the processor.
CPU0204	<b>Message</b>	CPU <number> <name> voltage is outside of range.
	<b>LCD Message</b>	CPU <number> <name> voltage is outside of range. Re-seat CPU.
	<b>Details</b>	Voltages outside the allowable range may damage electrical components or may cause the system to shutdown.
	<b>Action</b>	<ol style="list-style-type: none"> <li>1. Turn off the system and remove input power for one minute.</li> <li>2. Ensure the processor is seated correctly.</li> <li>3. Reapply input power and turn on the system.</li> <li>4. If the issue persists, see <a href="#">Getting Help</a>.</li> </ol>
CPU0700	<b>Message</b>	CPU <number> initialization error detected.
	<b>LCD Message</b>	CPU <number> initialization error detected. Power cycle system.
	<b>Details</b>	System BIOS was unable to initialize the processor.
	<b>Action</b>	<ol style="list-style-type: none"> <li>1. Turn off the system and remove input power for one minute.</li> <li>2. Ensure the processor is seated correctly.</li> <li>3. Reapply input power and turn on the system.</li> <li>4. If the issue persists, see <a href="#">Getting Help</a>.</li> </ol>
CPU0701	<b>Message</b>	CPU <number> protocol error detected.
	<b>LCD Message</b>	CPU <number> protocol error detected. Power cycle system.
	<b>Details</b>	System event log and operating system logs may indicate that the exception is external to the processor.
	<b>Action</b>	<ol style="list-style-type: none"> <li>1. Check system and operating system logs for exceptions. If no exceptions are found, continue.</li> </ol>

Error Code	Message Information	
		<ol style="list-style-type: none"> <li>2. Turn off the system and remove input power for one minute.</li> <li>3. Ensure the processor is seated correctly.</li> <li>4. Reapply input power and turn on the system.</li> <li>5. If the issue persists, see <a href="#">Getting Help</a>.</li> </ol>
CPU0702	<b>Message</b>	CPU bus parity error detected.
	<b>LCD Message</b>	CPU bus parity error detected. Power cycle system.
	<b>Details</b>	System event log and operating system logs may indicate that the exception is external to the processor.
	<b>Action</b>	<ol style="list-style-type: none"> <li>1. Check system and operating system logs for exceptions. If no exceptions are found, continue.</li> <li>2. Turn off the system and remove input power for one minute.</li> <li>3. Ensure the processor is seated correctly.</li> <li>4. Reapply input power and turn on the system.</li> <li>5. If the issue persists, see <a href="#">Getting Help</a>.</li> </ol>
CPU0703	<b>Message</b>	CPU bus initialization error detected.
	<b>LCD Message</b>	CPU bus initialization error detected. Power cycle system.
	<b>Details</b>	System event log and operating system logs may indicate that the exception is external to the processor.
	<b>Action</b>	<ol style="list-style-type: none"> <li>1. Check system and operating system logs for exceptions. If no exceptions are found, continue.</li> <li>2. Turn off the system and remove input power for one minute.</li> <li>3. Ensure the processor is seated correctly.</li> <li>4. Reapply input power and turn on the system.</li> <li>5. If the issue persists, see <a href="#">Getting Help</a>.</li> </ol>
CPU0704	<b>Message</b>	CPU <number> machine check error detected.
	<b>LCD Message</b>	CPU <number> machine check error detected. Power cycle system.
	<b>Details</b>	System event log and operating system logs may indicate that the exception is external to the processor.
	<b>Action</b>	<ol style="list-style-type: none"> <li>1. Check system and operating system logs for exceptions. If no exceptions are found, continue.</li> <li>2. Turn off the system and remove input power for one minute.</li> <li>3. Ensure the processor is seated correctly.</li> <li>4. Reapply input power and turn on the system.</li> </ol>

Error Code	Message Information	
FAN0000	<b>Message</b> <b>Details</b> <b>Action</b>	5. If the issue persists, see <a href="#">Getting Help</a> .  Fan <number> RPM is less than the lower warning threshold. Fan operating speed is out of range. Remove and reinstall the fan. If the issue persists, see <a href="#">Getting Help</a> .
FAN0001	<b>Message</b> <b>LCD Message</b> <b>Details</b> <b>Action</b>	Fan <number> RPM is less than the lower critical threshold. Fan <number> RPM is outside of range. Check fan. Fan operating speed is out of range. Remove and reinstall the fan. If the issue persists, see <a href="#">Getting Help</a> .
FAN1201	<b>Message</b> <b>LCD Message</b> <b>Details</b> <b>Action</b>	Fan redundancy is lost. Fan redundancy is lost. Check fans. Fan has failed. Remove and reinstall failed fans or install additional fans.
HWC1001	<b>Message</b> <b>LCD Message</b> <b>Details</b> <b>Action</b>	The <name> is absent. The <name> is absent. Check hardware. The absent device may be necessary for proper operation. System functionality may be degraded. Reinstall or reconnect the hardware.
HWC2003	<b>Message</b> <b>LCD Message</b> <b>Details</b> <b>Action</b>	The storage <name> cable is not connected, or is improperly connected. Storage <name> cable or interconnect failure. Check connection. The cable may be necessary for proper operation. System functionality may be degraded. Check if the cable is present, then reinstall or reconnect.
HWC2005	<b>Message</b> <b>LCD Message</b> <b>Details</b>	The system board <name> cable is not connected, or is improperly connected. System board <name> cable connection failure. Check connection. The cable may be necessary for proper operation. System functionality may be degraded.

Error Code	Message Information	
	<b>Action</b>	Check if the cable is present, then reinstall or reconnect.
<b>MEM0000</b>	<b>Message</b>	Persistent correctable memory errors detected on a memory device at location(s) <i>&lt;location&gt;</i> .
	<b>Details</b>	This is an early indicator of a possible future uncorrectable error.
	<b>Action</b>	Re-seat the memory modules. If the issue persists, see <a href="#">Getting Help</a> .
<b>MEM0001</b>	<b>Message</b>	Multi-bit memory errors detected on a memory device at location(s) <i>&lt;location&gt;</i> .
	<b>LCD Message</b>	Multi-bit memory error on <i>&lt;location&gt;</i> . Re-seat memory.
	<b>Details</b>	The memory module has encountered an uncorrectable error. System performance may be degraded. The operating system and/or applications may fail as a result.
	<b>Action</b>	Re-seat the memory modules. If the issue persists, see <a href="#">Getting Help</a> .
<b>MEM0007</b>	<b>Message</b>	Unsupported memory configuration; check memory device at location <i>&lt;location&gt;</i> .
	<b>LCD Message</b>	Unsupported memory configuration. Check memory <i>&lt;location&gt;</i> .
	<b>Details</b>	The memory may not be seated correctly, misconfigured, or has failed. Memory size is reduced.
	<b>Action</b>	Check the memory configuration. Re-seat the memory modules. If the issue persists, see <a href="#">Getting Help</a> .
<b>MEM0701</b>	<b>Message</b>	Correctable memory error rate exceeded for <i>&lt;location&gt;</i> .
	<b>Details</b>	The memory may not be operational. This an early indicator of a possible future uncorrectable error.
	<b>Action</b>	Re-seat the memory modules. If the issue persists, see <a href="#">Getting Help</a> .
<b>MEM0702</b>	<b>Message</b>	Correctable memory error rate exceeded for <i>&lt;location&gt;</i> .
	<b>LCD Message</b>	Correctable memory error rate exceeded for <i>&lt;location&gt;</i> . Re-seat memory.
	<b>Details</b>	The memory may not be operational. This an early indicator of a possible future uncorrectable error.
	<b>Action</b>	Re-seat the memory modules. If the issue persists, see <a href="#">Getting Help</a> .
<b>MEM1205</b>	<b>Message</b>	Memory mirror redundancy is lost. Check memory device at location(s) <i>&lt;location&gt;</i> .

Error Code	Message Information	
	<b>LCD Message</b>	Memory mirror lost on <i>&lt;location&gt;</i> . Power cycle system.
	<b>Details</b>	The memory may not be seated correctly, misconfigured, or has failed.
	<b>Action</b>	Check the memory configuration. Re-seat the memory modules. If the issue persists, see <a href="#">Getting Help</a> .
MEM1208	<b>Message</b>	Memory spare redundancy is lost. Check memory device at location <i>&lt;location&gt;</i> .
	<b>LCD Message</b>	Memory spare lost on <i>&lt;location&gt;</i> . Power cycle system.
	<b>Details</b>	Memory sparing is no longer available.
	<b>Action</b>	Re-seat the memory modules. If the issue persists, see <a href="#">Getting Help</a> .
MEM8000	<b>Message</b>	Correctable memory error logging disabled for a memory device at location <i>&lt;location&gt;</i> .
	<b>LCD Message</b>	SBE log disabled on <i>&lt;location&gt;</i> . Re-seat memory.
	<b>Details</b>	Errors are being corrected but no longer logged.
	<b>Action</b>	Review system logs for memory exceptions. Reinstall memory at location <i>&lt;location&gt;</i> .
PCI1302	<b>Message</b>	A bus time-out was detected on a component at bus <i>&lt;bus&gt;</i> device <i>&lt;device&gt;</i> function <i>&lt;func&gt;</i> .
	<b>Details</b>	System performance may be degraded. The device has failed to respond to a transaction.
	<b>Action</b>	Cycle input power, update component drivers, if device is removable, reinstall the device.
PCI1304	<b>Message</b>	An I/O channel check error was detected.
	<b>LCD Message</b>	I/O channel check error detected. Power cycle system.
	<b>Action</b>	Cycle input power, update component drivers, if device is removable, reinstall the device.
PCI1308	<b>Message</b>	A PCI parity error was detected on a component at bus <i>&lt;bus&gt;</i> device <i>&lt;device&gt;</i> function <i>&lt;func&gt;</i> .
	<b>LCD Message</b>	PCI parity error on bus <i>&lt;bus&gt;</i> device <i>&lt;device&gt;</i> function <i>&lt;func&gt;</i> . Power cycle system.
	<b>Details</b>	System performance may be degraded, PCI device may fail to operate, or system may fail to operate.

Error Code	Message Information	
	<b>Action</b>	Cycle input power, update component drivers, if device is removable, reinstall the device.
PCI1320	<b>Message</b>	A bus fatal error was detected on a component at bus <bus>device<device>function <func>.
	<b>LCD Message</b>	Bus fatal error on bus <bus> device <device> function <func>. Power cycle system.
	<b>Details</b>	System performance may be degraded, or system may fail to operate.
	<b>Action</b>	Cycle input power, update component drivers, if device is removable, reinstall the device.
PCI1342	<b>Message</b>	A bus time-out was detected on a component at slot <number>.
	<b>Details</b>	System performance may be degraded, or system may fail to operate.
	<b>Action</b>	Cycle input power, update component drivers, if device is removable, reinstall the device.
PCI1348	<b>Message</b>	A PCI parity error was detected on a component at slot <number>.
	<b>LCD Message</b>	PCI parity error on slot <number>. Re-seat PCI card.
	<b>Details</b>	System performance may be degraded, or system may fail to operate.
	<b>Action</b>	Cycle input power, update component drivers, if device is removable, reinstall the device.
PCI1360	<b>Message</b>	A bus fatal error was detected on a component at slot <number>.
	<b>LCD Message</b>	Bus fatal error on slot <number>. Re-seat PCI card.
	<b>Details</b>	System performance may be degraded, or system may fail to operate.
	<b>Action</b>	Cycle input power, update component drivers, if device is removable, reinstall the device.
PDR0001	<b>Message</b>	Fault detected on drive <number>.
	<b>LCD Message</b>	Fault detected on drive <number>. Check drive.
	<b>Details</b>	The controller detected a failure on the disk and has taken the disk offline.
	<b>Action</b>	Remove and re-seat the failed disk. If the issue persists, see <a href="#">Getting Help</a> .
PDR1016	<b>Message</b>	Drive <number> is removed from disk drive bay <bay>.

Error Code	Message Information	
PST0128	<b>LCD Message</b>	Drive <number> removed from disk drive bay <bay>. Check drive.
	<b>Details</b>	The controller detected that the drive was removed.
	<b>Action</b>	Verify drive installation. Re-seat the failed drive. If the issue persists, see <a href="#">Getting Help</a> .
	<b>Message</b>	No memory is detected.
PST0129	<b>LCD Message</b>	No memory is detected. Inspect memory devices.
	<b>Details</b>	System BIOS was unable to detect memory in the system.
	<b>Action</b>	Re-seat the memory modules. If the issue persists, see <a href="#">Getting Help</a> .
	<b>Message</b>	Memory is detected, but is not configurable.
PSU0001	<b>LCD Message</b>	Memory is detected, but is not configurable. Check memory devices.
	<b>Details</b>	System BIOS detected memory, but was unable to configure the memory for system operation.
	<b>Action</b>	Compare system memory installation to supported system memory configurations.
	<b>Message</b>	Power supply <number> failed.
PSU0002	<b>LCD Message</b>	PSU <number> failed. Check PSU.
	<b>Action</b>	Remove and reinstall the power supply. If the issue persists, see <a href="#">Getting Help</a> .
	<b>Message</b>	A predictive failure detected on power supply <number>.
	<b>LCD Message</b>	Predictive failure on PSU <number>. Check PSU.
PSU0003	<b>Details</b>	System performance and power redundancy may be degraded or lost.
	<b>Action</b>	Remove and reinstall the power supply at the next service window. If the issue persists, see <a href="#">Getting Help</a> .
	<b>Message</b>	The power input for power supply <number> is lost.
	<b>LCD Message</b>	Power input for PSU <number> is lost. Check PSU cables.
<b>Details</b>	The power supply is installed correctly but an input source is not connected or is not functional.	
<b>Action</b>	Verify the input source is attached to the power supply. Verify the input power is within the operating requirements for the power supply.	



Error Code	Message Information	
PSU0006	<b>Message</b>	Power supply <number> type mismatch.
	<b>LCD Message</b>	Power supply <number> is incorrectly configured. Check PSU.
	<b>Details</b>	Power supplies should be of the same input type and power rating.
	<b>Action</b>	Install matched power supplies and review proper configuration in this manual.
PSU0016	<b>Message</b>	Power supply <number> is absent.
	<b>LCD Message</b>	PSU <number> is absent. Check PSU.
	<b>Details</b>	The power supply has been removed or has failed.
	<b>Action</b>	<ol style="list-style-type: none"> <li>1. Remove and reinstall the power supply.</li> <li>2. Check cables and subsystem components in the system for damage.</li> <li>3. If the issue persists, see <a href="#">Getting Help</a>.</li> </ol>
PSU0031	<b>Message</b>	Cannot communicate with power supply <number>.
	<b>LCD Message</b>	Cannot communicate with PSU <number>. Re-seat PSU.
	<b>Details</b>	The power supply may operate, however power supply monitoring is degraded. System performance may be degraded.
	<b>Action</b>	Remove and reinstall the power supply. If the issue persists, see <a href="#">Getting Help</a> .
PSU0032	<b>Message</b>	The temperature for power supply <number> is in a warning range.
	<b>Details</b>	System performance may be degraded.
	<b>Action</b>	Check the system operating environment, including airflow and inlet temperature. Check system logs for temperature and thermal component failures.
PSU0033	<b>Message</b>	The temperature for power supply <number> is outside of the allowable range.
	<b>LCD Message</b>	PSU <number> temperature outside of range. Check PSU.
	<b>Details</b>	System performance may be degraded.
	<b>Action</b>	Check the system operating environment, including airflow and inlet temperature. Check system logs for temperature and thermal component failures.

Error Code	Message Information	
PSU0034	<b>Message</b>	An under voltage fault detected on power supply <number>.
	<b>LCD Message</b>	An under voltage fault detected on PSU <number>. Check power source.
	<b>Details</b>	This failure may be the result of an electrical issue with cables or subsystem components in the system.
	<b>Action</b>	<ol style="list-style-type: none"> <li>1. Remove and reinstall the power supply.</li> <li>2. Check cables and subsystem components in the system for damage.</li> <li>3. If the issue persists, see <a href="#">Getting Help</a>.</li> </ol>
PSU0035	<b>Message</b>	An over voltage fault detected on power supply <number>.
	<b>LCD Message</b>	Over voltage fault on PSU <number>. Check PSU.
	<b>Action</b>	Check input power or reinstall the power supply. If the issue persists, see <a href="#">Getting Help</a> .
PSU0036	<b>Message</b>	An over current fault detected on power supply <number>.
	<b>LCD Message</b>	An over current fault detected on PSU <number>. Check PSU.
	<b>Details</b>	This failure may be the result of an electrical issue with cables or subsystem components in the system.
	<b>Action</b>	<ol style="list-style-type: none"> <li>1. Remove and reinstall the power supply.</li> <li>2. Check cables and subsystem components in the system for damage.</li> <li>3. If the issue persists, see <a href="#">Getting Help</a>.</li> </ol>
PSU0037	<b>Message</b>	Fan failure detected on power supply <number>.
	<b>LCD Message</b>	Fan failure detected on PSU <number>. Check PSU.
	<b>Action</b>	Check for fan blockage. If the problem persists, see <a href="#">Getting Help</a> .
PSU0076	<b>Message</b>	A power supply wattage mismatch is detected; power supply <number> is rated for <value> watts.
	<b>LCD Message</b>	PSU wattage mismatch; PSU <number> = <value>watts
	<b>Details</b>	Power supplies should be of the same input type and power rating.
	<b>Action</b>	Install matched power supplies and review this manual for proper configuration.

<b>Error Code</b>	<b>Message Information</b>	
<b>PSU1201</b>	<b>Message</b>	Power supply redundancy is lost.
	<b>Details</b>	The power supply tries to operate in a degraded state. System Performance and power redundancy may be degraded or lost.
	<b>Action</b>	Check input power. Reinstall the power supply. If the issue persists, see <a href="#">Getting Help</a> .
<b>PSU1204</b>	<b>Message</b>	The power supplies are not redundant. Insufficient resources to maintain normal operations.
	<b>LCD Message</b>	PSU redundancy degraded. Check PSU cables.
	<b>Details</b>	The current power operational mode is non-redundant because of a power supply exception, a power supply inventory change, or a system power inventory change.
	<b>Action</b>	Check the event log for power supply failures. Review system configuration and power consumption.
<b>PWR1004</b>	<b>Message</b>	The system performance degraded because power capacity has changed.
	<b>Details</b>	The system may power down or operate in a performance degraded state.
	<b>Action</b>	Check the event log for power supply failures. Review system configuration and power consumption and upgrade or install power supplies accordingly.
<b>PWR1005</b>	<b>Message</b>	The system performance degraded because the user-defined power capacity has changed.
	<b>Details</b>	The user-defined power settings have affected system operation.
	<b>Action</b>	If unintended, review system configuration changes and power policy.
<b>PWR1006</b>	<b>Message</b>	The system halted because system power exceeds capacity.
	<b>LCD Message</b>	System power demand exceeds capacity. System halted.
	<b>Details</b>	The system halted because system power exceeds capacity.
	<b>Action</b>	Review system configuration, upgrade power supplies or reduce system power consumption.
<b>RFM1008</b>	<b>Message</b>	Failure detected on Removable Flash Media <name>.
	<b>LCD Message</b>	Removable Flash Media <name> failed. Check SD Card.

Error Code	Message Information	
	<b>Details</b>	An error was reported during a SD card read or write.
	<b>Action</b>	Reseat the flash media. If the problem persists, see <a href="#">Getting Help</a> .
<b>RFM1014</b>	<b>Message</b>	Removable Flash Media <name> is write protected.
	<b>LCD Message</b>	Removable Flash Media <name> is write protected. Check SD Card.
	<b>Details</b>	The card is write-protected by the physical latch on the SD card. A write-protected card cannot be used.
	<b>Action</b>	If unintended, remove the media and disable write protection.
<b>RFM1201</b>	<b>Message</b>	Internal Dual SD Module redundancy is lost.
	<b>LCD Message</b>	Internal Dual SD Module redundancy is lost. Check SD Card.
	<b>Details</b>	Either one or both the SD cards are not functioning properly.
	<b>Action</b>	See <a href="#">Getting Help</a> .
<b>RFM2001</b>	<b>Message</b>	Internal Dual SD Module <name> is absent.
	<b>LCD Message</b>	Internal Dual SD Module <name> is absent. Check SD Card.
	<b>Details</b>	The SD card module is not detected or not installed.
	<b>Action</b>	If unintended, reinstall the SD module.
<b>RFM2002</b>	<b>Message</b>	Internal Dual SD Module <name> is offline.
	<b>Details</b>	The SD card module is installed but may be improperly installed or configured incorrectly.
	<b>Action</b>	Reinstall the SD module.
<b>RFM2004</b>	<b>Message</b>	Failure detected on Internal Dual SD Module <name>.
	<b>LCD Message</b>	Internal Dual SD Module <name> failed. Check SD Card.
	<b>Details</b>	The SD card module is installed but improperly configured or failed to initialize.
	<b>Action</b>	Reinstall the SD module and remove and reinstall SD cards.
<b>RFM2006</b>	<b>Message</b>	Internal Dual SD Module <name> is write protected.
	<b>Details</b>	The module is write-protected. Changes may not be written to the media.
	<b>Action</b>	If unintended, remove the media and disable write protection.

<b>Error Code</b>	<b>Message Information</b>	
<b>SEC0031</b>	<b>Message</b>	The chassis is open while the power is on.
	<b>LCD Message</b>	Intrusion detected. Check chassis cover.
	<b>Details</b>	The chassis is open. System performance may be degraded, and security may be compromised.
	<b>Action</b>	Close the chassis. Check system logs.
<b>SEC0033</b>	<b>Message</b>	The chassis is open while the power is off.
	<b>LCD Message</b>	Intrusion detected. Check chassis cover.
	<b>Details</b>	The chassis was opened while the power was off. System security may have been compromised.
	<b>Action</b>	Close the chassis and verify hardware inventory. Check system logs.
<b>SEL0006</b>	<b>Message</b>	All event logging is disabled.
	<b>Details</b>	This message is displayed when all event logging has been disabled by the user.
	<b>Action</b>	If unintended, re-enable logging.
<b>SEL0008</b>	<b>Message</b>	Log is full.
	<b>Details</b>	When the event log is full, additional events are not written to the log. Older events may be overwritten and lost. This message may also appear if the user disabled event logging.
	<b>Action</b>	Backup and clear log.
<b>SEL0012</b>	<b>Message</b>	Could not create or initialize the system event log.
	<b>Details</b>	If the system event log fails to initialize, platform status and failure events are not captured. Some management software do not report platform exceptions.
	<b>Action</b>	Reboot the management controller or iDRAC. Cycle system input power. If problem persists call support.
<b>SEL1204</b>	<b>Message</b>	An unknown system hardware failure detected.
	<b>LCD Message</b>	Unknown system hardware failure.
	<b>Details</b>	If the system event log failed to initialize, platform status and failure events are not captured. Some management software do not report platform exceptions.

Error Code	Message Information	
TMP0118	<b>Action</b>	Re-configure system to the minimum supported configuration. If issues persists, contact support.
	<b>Message</b>	The system inlet temperature is less than the lower warning threshold.
	<b>LCD Message</b>	System inlet temperature is outside of range.
	<b>Details</b>	Ambient air temperature is too cool.
TMP0119	<b>Action</b>	Check the system operating environment.
	<b>Message</b>	The system inlet temperature is less than the lower critical threshold.
	<b>LCD Message</b>	System inlet temperature is outside of range.
	<b>Details</b>	Ambient air temperature is too cool.
TMP0120	<b>Action</b>	Check the system operating environment.
	<b>Message</b>	The system inlet temperature is greater than the upper warning threshold.
	<b>LCD Message</b>	System inlet temperature is outside of range.
	<b>Details</b>	Ambient air temperature is too warm or one or more fans may have failed.
TMP0121	<b>Action</b>	Check the system operating environment and review event log for fan failures.
	<b>Message</b>	The system inlet temperature is greater than the upper critical threshold.
	<b>LCD Message</b>	System inlet <name> temperature is outside of range. Check Fans.
	<b>Details</b>	Ambient air temperature is too warm or one or more fans may have failed.
VLT0204	<b>Action</b>	Check the system operating environment and review event log for fan failures.
	<b>Message</b>	The system board <name> voltage is outside of the allowable range.
	<b>LCD Message</b>	System board voltage is outside of range.
	<b>Details</b>	System hardware detected an over voltage or under voltage condition.  If multiple voltage exceptions occur consecutively the system may power down in fail-safe mode.

Error Code	Message Information
	Action
	<ol style="list-style-type: none"> <li>1. Review system logs for power supply exceptions.</li> <li>2. Re-configure the system to minimum configuration, inspect and reinstall system cables.</li> <li>3. If the issue persists, see <a href="#">Getting Help</a>.</li> </ol>

## Warning Messages

A warning message alerts you to a possible problem and prompts you to respond before the system continues a task. For example, before you format a hard drive, a message warns you that you may lose all data on the hard drive. Warning messages usually interrupt the task and require you to respond by typing y (yes) or n (no).

 **NOTE:** Warning messages are generated by either the application or the operating system. For more information, see the documentation that accompanied the operating system or application.

## Diagnostic Messages

The system diagnostic utilities may issue messages if you run diagnostic tests on your system. See “Using System Diagnostics” chapter for more information about system diagnostics.

## Alert Messages

Systems management software generates alert messages for your system. Alert messages include information, status, warning, and failure messages for drive, temperature, fan, and power conditions. For more information, see the systems management software documentation.





# Getting Help

## Contacting Dell

 **NOTE:** If you do not have an active Internet connection, you can find contact information on your purchase invoice, packing slip, bill, or Dell product catalog.

Dell provides several online and telephone-based support and service options. Availability varies by country and product, and some services may not be available in your area. To contact Dell for sales, technical support, or customer service issues:

1. Visit [dell.com/support](http://dell.com/support)
2. Select your support category.
3. Verify your country or region in the Choose a Country/Region drop-down menu at the top of page.
4. Select the appropriate service or support link based on your need.